



Manuale per il Tecnico
Manual for Technical

CAFE RACER

Italiano 

English..... 

INDICE

1. Introduzione	3
1.1 Avvertenze generali di sicurezza	3
2. Rimozione bacinella	4
3. Rimozione scaldatazze	6
4. Rimozione pannellature	7
4.1 Rimozione fianco tubolari	7
4.2 Rimozione pannello posteriore	8
4.3 Rimozione carter gruppo caffè	9
4.4 Rimozione pannello anteriore inferiore	10
5. Topografia componenti principali	11
5.1 Vista superiore	11
5.2 Vista posteriore	12
5.3 Vista laterale sinistra	13
5.4 Vista laterale destra	14
5.5 Rimozione pannello elettrico	15
5.6 Topografia pannello elettrico	15
6. Regolazioni - ripristini	16
6.1 Regolazione acqua miscelata	16
6.2 Spurgo aria dal circuito	16
6.3 Ripristino termostato di sicurezza caldaia servizi	16
6.4 Ripristino termostato di sicurezza caldaiette	17
6.5 Ripristino termostato di sicurezza gruppo	17
7. Rimozioni - sostituzioni	18
7.1 Sostituzione resistenza scaldatazze	18
7.2 Sostituzione sonda scaldatazze	18
7.3 Sostituzione resistenza caldaietta	19
7.4 Sostituzione termostato caldaietta	21
7.5 Sostituzione caldaietta gruppo	21
7.6 Sostituzione resistenza caldaia caffè	23
7.7 Sostituzione pompa	24
7.8 Sostituzione motore pompa	25
7.9 Sostituzione piastra led	26
7.10 Sostituzione elettrovalvola carico caldaia	26
7.11 Sostituzione elettrovalvola acqua miscelata	27
7.12 Sostituzione elettrovalvola acqua calda	28
7.13 Sostituzione elettrovalvola cooling cycle	29
7.14 Sostituzione elettrovalvola purge	29
7.15 Sostituzione elettrovalvola preinfusione	31
7.16 Sostituzione elettrovalvola gruppo	31
7.17 Sostituzione contatore volumetrico	32
7.18 Sostituzione trasduttore di pressione pompa	33
7.19 Sostituzione trasduttore di pressione caldaia servizi	33
7.20 Sostituzione scheda espansione preinfusione	34
7.21 Sostituzione scheda elettronica	34
7.22 Sostituzione componenti pannello elettrico	35
7.23 Sostituzione scheda display	36
7.24 Sostituzione display gruppo	37
7.25 Rimozione caldaia servizi	39
7.26 Sostituzione rubinetto vapore	40
7.27 Sostituzione termostato di sicurezza	41
7.28 Sostituzione pulsante rubinetto erogazione acqua	41
7.29 Sostituzione barra led	42
7.30 Sostituzione interruttore generale	43
7.31 Smontaggio doccetta e guarnizioni	44

IT

8. Programmazione del tecnico..... 45

- 8.1 Lingua..... 46
- 8.2 Nome..... 46
- 8.3 Tel. Assistenza..... 46
- 8.4 Numero gruppi..... 46
- 8.5 Funzione crono..... 47
- 8.6 Carico + caffè 47
- 8.7 Watt 47
- 8.8 Trasduttore pressione vapore..... 47
- 8.9 Offset pressione pompa 48
- 8.10 Programmazione dosi 48
- 8.11 Quattro dosi 48
- 8.12 Offset contatore volumetrico 1-2-3 48
- 8.13 Sensibilità 49
- 8.14 Cicli manutenzione 49
- 8.15 Temperatura 49
- 8.16 Temperatura (C° / F°) 49
- 8.17 Temperatura caldaia..... 50
- 8.18 Offset temperatura gruppo 50
- 8.19 Tempo di inattività..... 50
- 8.20 Timeout riempimento..... 51
- 8.21 Filtro acqua..... 51
- 8.22 Numero crediti 51
- 8.23 Ciclo di raffreddamento 51
- 8.24 Password..... 52
- 8.25 Funzione conto cassa e lavaggi 57
- 8.26 Lista allarmi 59

9. Schema idraulico..... 60

10. Schema elettrico..... 61

1. INTRODUZIONE

- Questo manuale è stato redatto per un uso esclusivo da parte dei tecnici autorizzati della ditta costruttrice.

1.1 Avvertenze generali di sicurezza

- Quando ci si appresta a operare sulla macchina è necessario accertarsi che l'interruttore generale e l'interruttore della macchina siano in posizione "OFF" e il rubinetto di alimentazione idrica chiuso.
- Quando è necessario effettuare alcune operazioni/regolazioni con l'alimentazione elettrica inserita **è necessario operare con estrema cautela**.
- Quando ci si appresta a operare sulla macchina è necessario controllare che l'acqua contenuta nella macchina sia fredda.
- Quando è necessario effettuare alcune operazioni/regolazioni con la macchina in temperatura di lavoro **è necessario operare con estrema cautela** e adeguati mezzi di protezione individuale.
- È comunque necessario indossare adeguati mezzi di protezione individuale come richiesto dalle normative in vigore nel paese di utilizzo.
- È comunque necessario operare seguendo le norme specifiche in vigore nel paese di utilizzo.
- Per tutte le operazioni riguardanti l'impianto elettrico fare riferimento allo schema elettrico allegato.
- Per tutte le operazioni riguardanti l'impianto idraulico fare riferimento allo schema idraulico allegato.

2. RIMOZIONE BACINELLA

- Rimuovere la griglia (1).



- Sollevare e rimuovere la bacinella (2).



- Svitare le quattro viti a brugola (3).

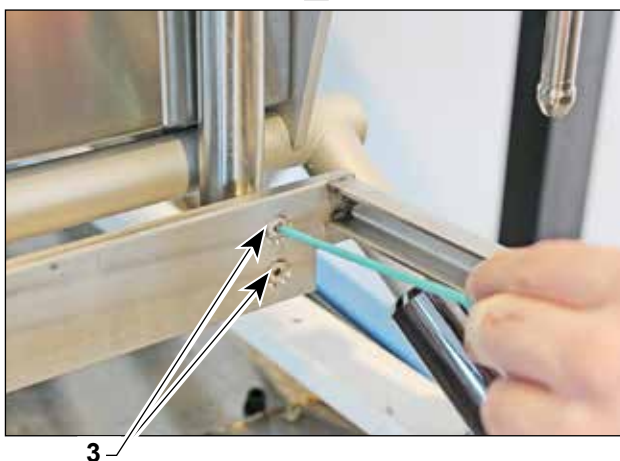
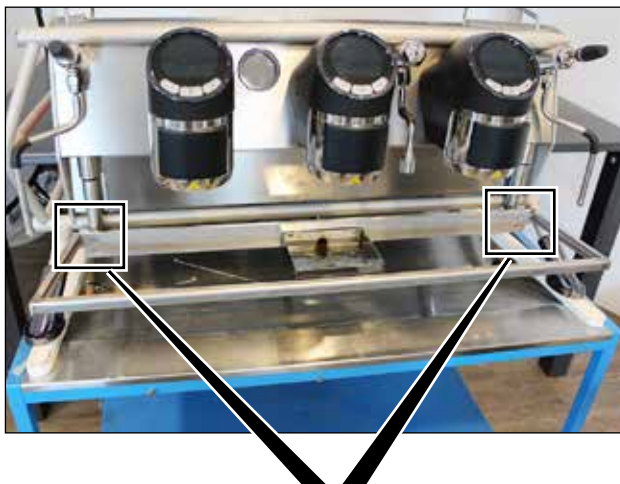

IT

- Allentare la vite (4) e staccare il supporto bacinella (5).



-  Al rimontaggio della bacinella (5) verificare lo stato delle guarnizioni OR (6) e ingrassarle.



IT

3. RIMOZIONE SCALDATAZZE

- Svitare la vite (1) da entrambe i lati.

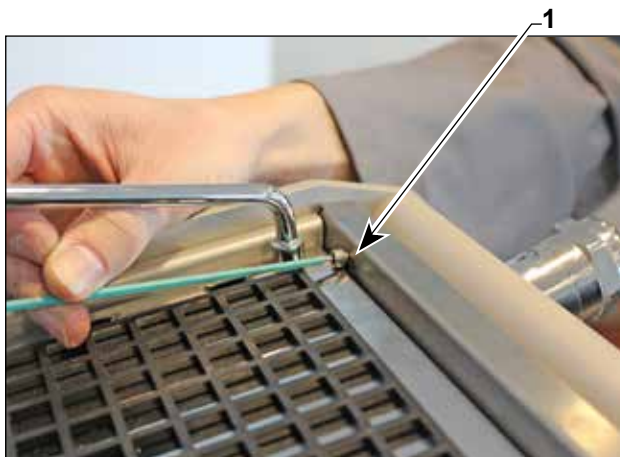

- Rimuovere le griglie (2).

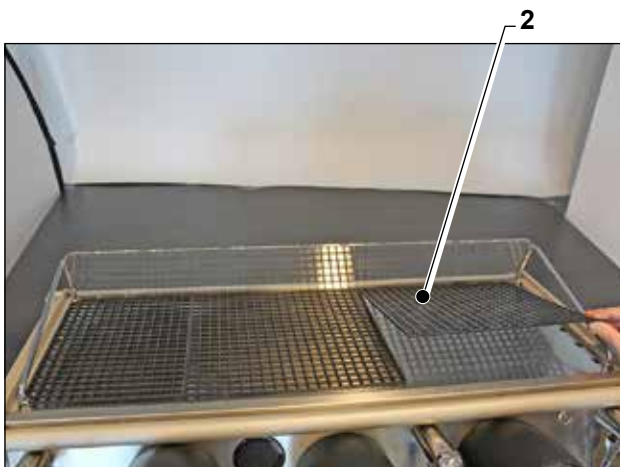

- Sollevare il piano scaldatazze (3).

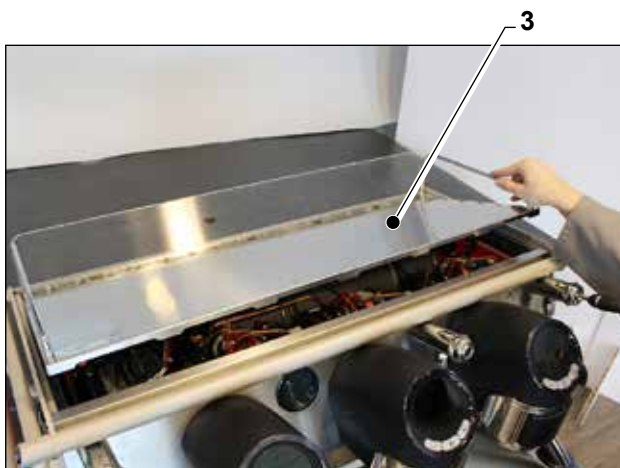

- Scollegare il connettore (4) della sonda.
- Scollegare il connettore resistenze (5).
- Rimuovere il piano scaldatazze (3).

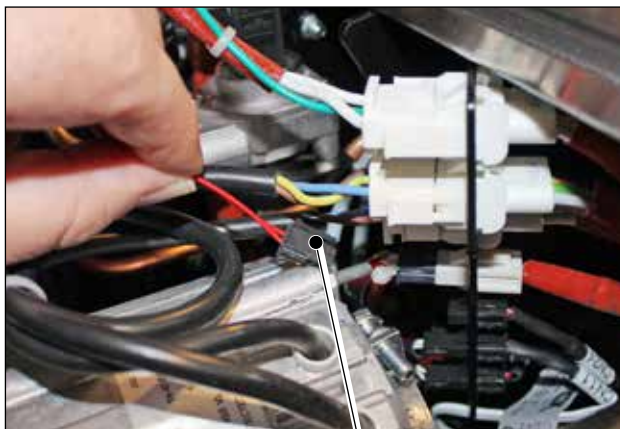
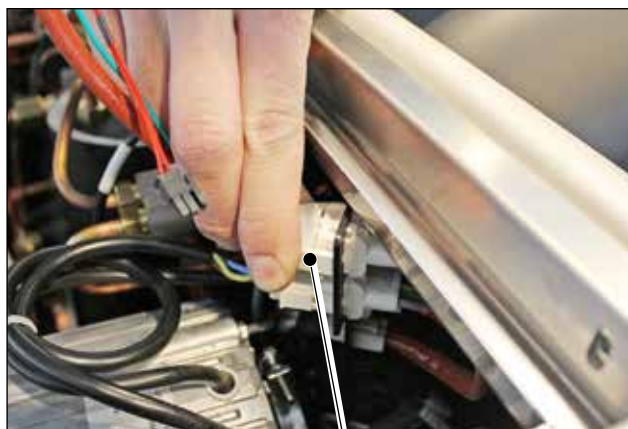

IT

4. RIMOZIONE PANNELLATURE

 Rimuovendo i pannelli laterali e il piano scaldatozze è possibile accedere a tutti i componenti interni della macchina.

4.1 Rimozione fianco tubolari

- Svitare le viti (1).

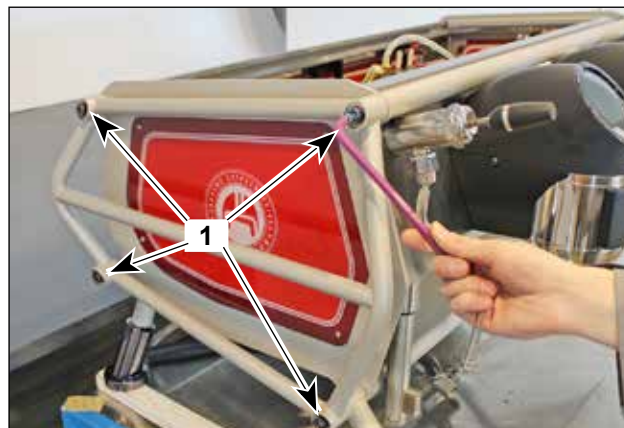

- Rimuovere il fianco tubolare (2).

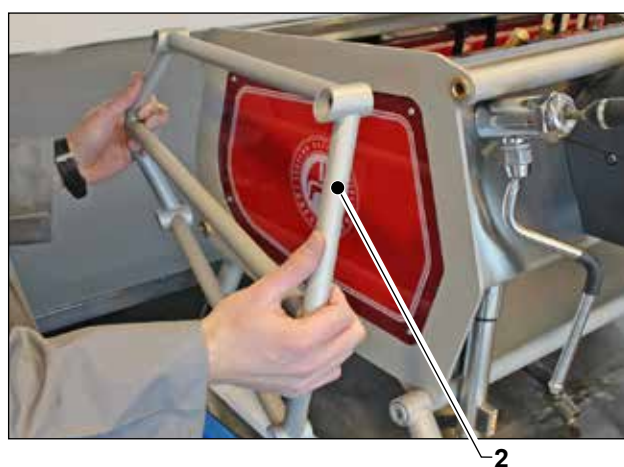

- Svitare le viti (3) che fissano il pannello (4).

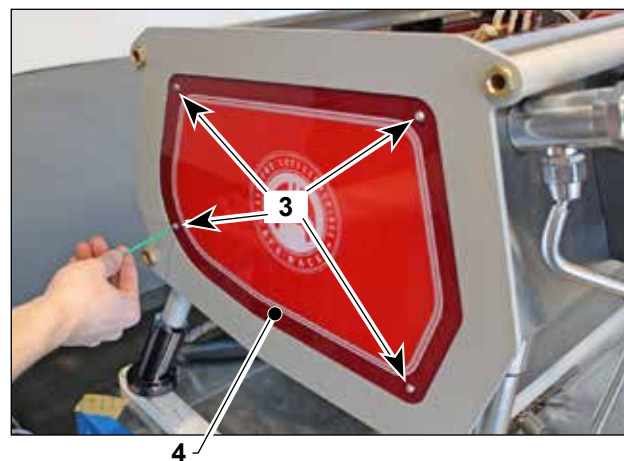

- Rimuovere il pannello (4).



IT

4.2 Rimozione pannello posteriore

- Svitare le due viti laterali (1).

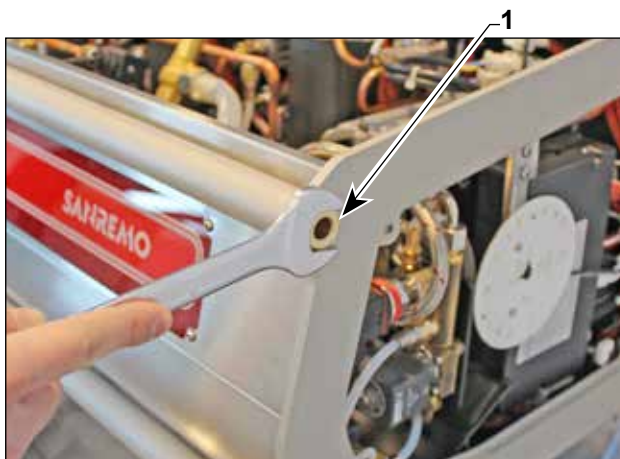

- Rimuovere il tubo (2) di collegamento delle due spalle.

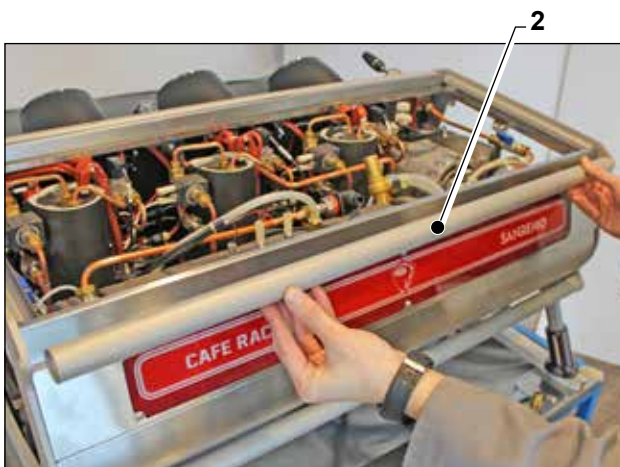

- Svitare le tre viti (3).
- Allentare le tre viti (4).

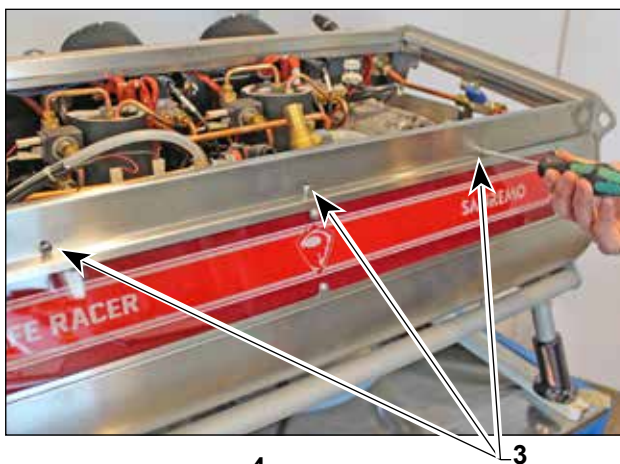

IT

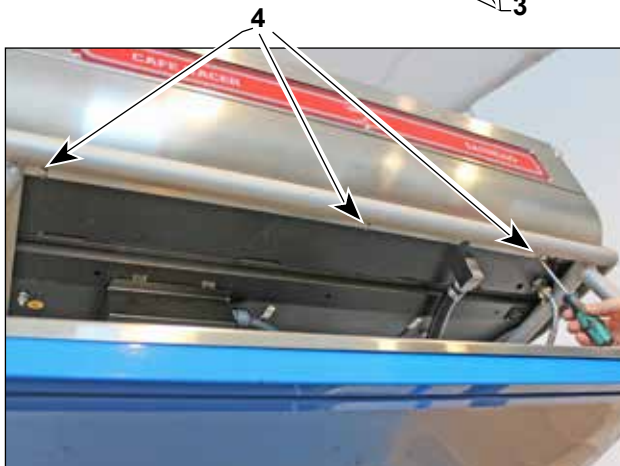
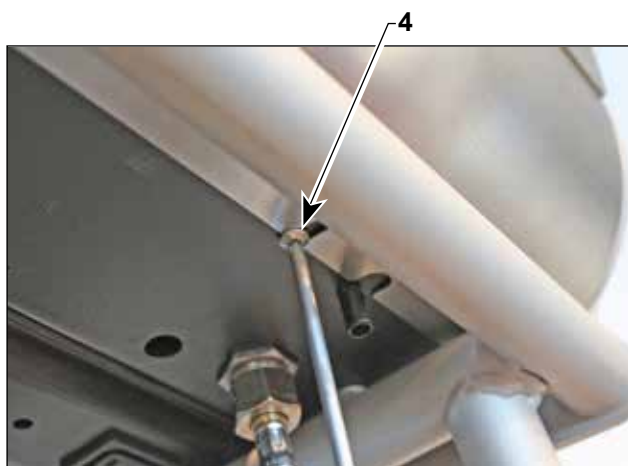

- Rimuovere il pannello posteriore (5).

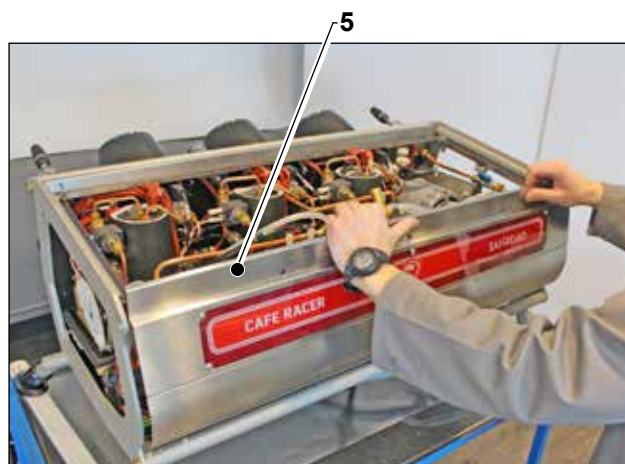

4.3 Rimozione carter gruppo caffè

- Svitare dai due lati le viti (1).

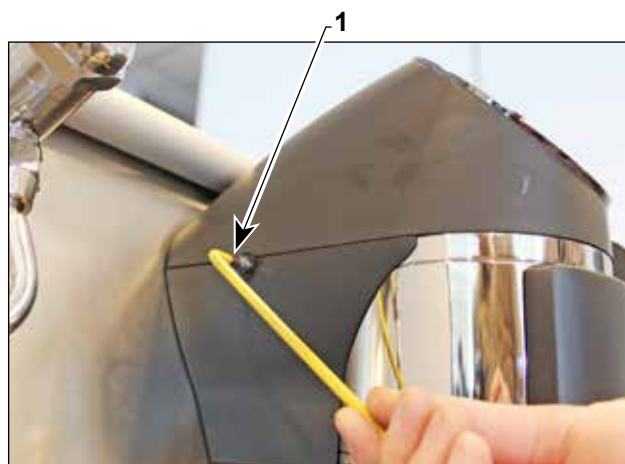

- Allargare i due carterini (2) e rimuoverli.



- Sfilare verso la parte anteriore il carterino (3) con il display.

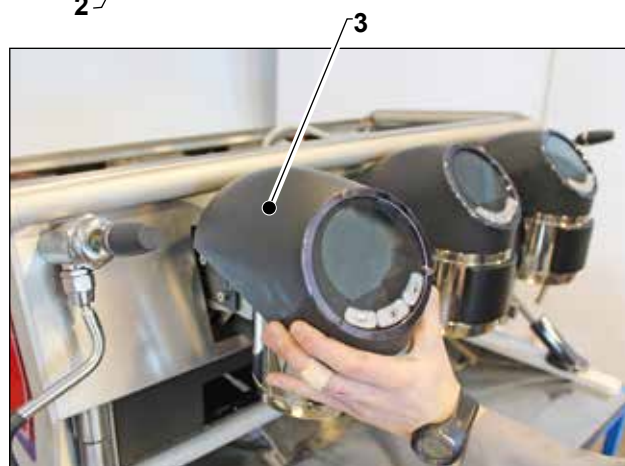

IT

- Scollegare i connettori (4) e (5).

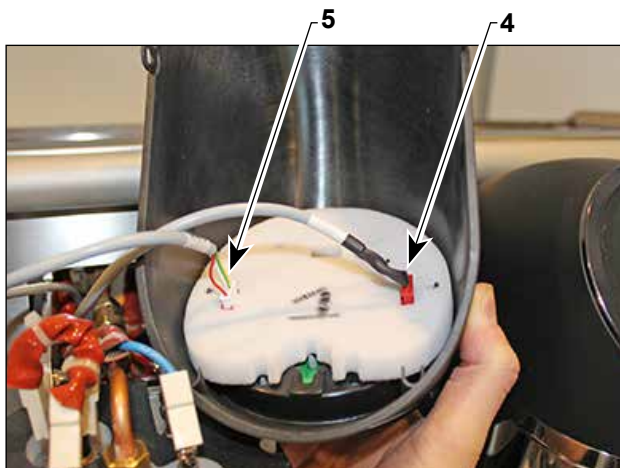

4.4 Rimozione pannello anteriore inferiore

- Allentare le due viti (1) a croce.

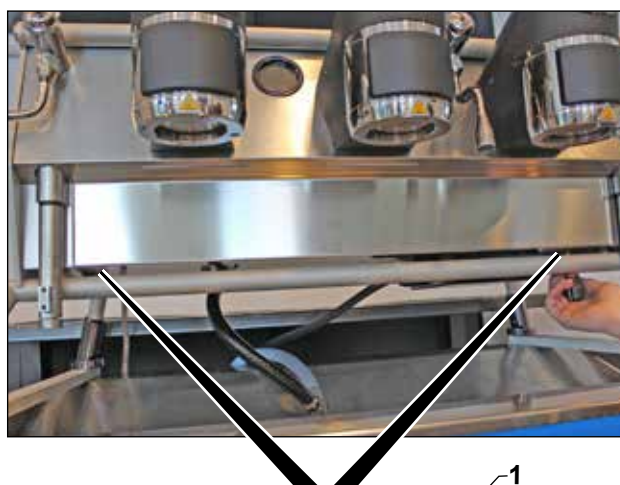

- Estrarre il pannello (2).

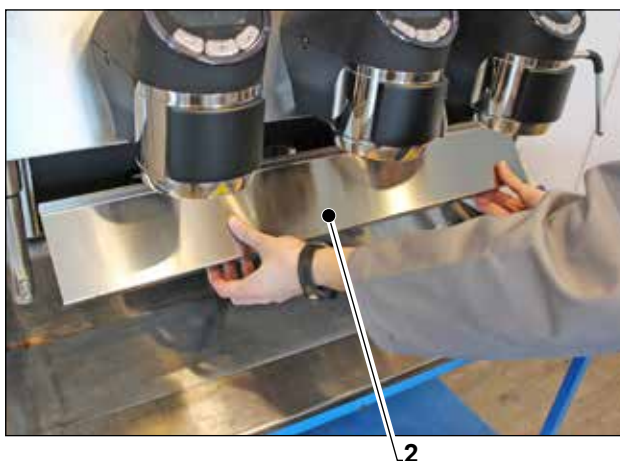

IT

5. TOPOGRAFIA COMPONENTI PRINCIPALI

5.1 Vista Superiore

- 1) Caldaietta gruppo "1"
- 2) Caldaietta gruppo "2"
- 3) Caldaietta gruppo "3"
- 4) Contatore volumetrico gruppo "1"
- 5) Contatore volumetrico gruppo "2"
- 6) Contatore volumetrico gruppo "3"
- 7) Elettrovalvola preinfusione gruppo "1"
- 8) Elettrovalvola preinfusione gruppo "2"
- 9) Elettrovalvola preinfusione gruppo "3"
- 10) Rubinetto intercettazione lancia vapore dx
- 11) Rubinetto intercettazione lancia vapore sx
- 12) Caldaia servizi
- 13) Trasduttore di pressione vapore
- 14) Valvola di sicurezza
- 15) Motore pompa
- 16) Pompa acqua
- 17) Elettrovalvola di scarico
- 18) Rubinetto intercettazione gruppo 1
- 19) Rubinetto intercettazione gruppo 2
- 20) Rubinetto intercettazione gruppo 3

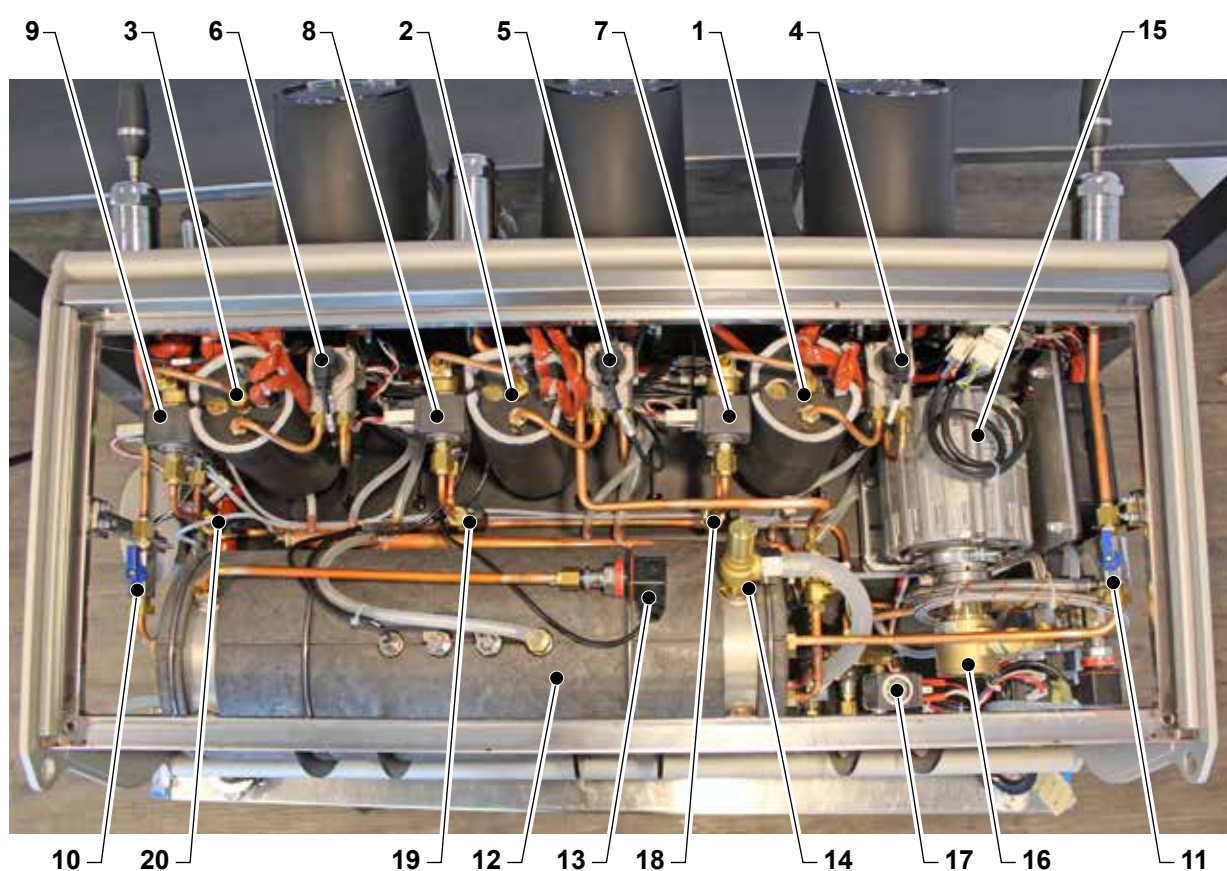

IT

5.2 Vista posteriore

- 1) Caldaia servizi
- 2) Collettore di scarico
- 3) Elettrovalvola cooling cycle (rigenerazione acqua caldaia)
- 4) Rubinetto scarico caldaia vapore
- 5) Elettrovalvola acqua miscelata

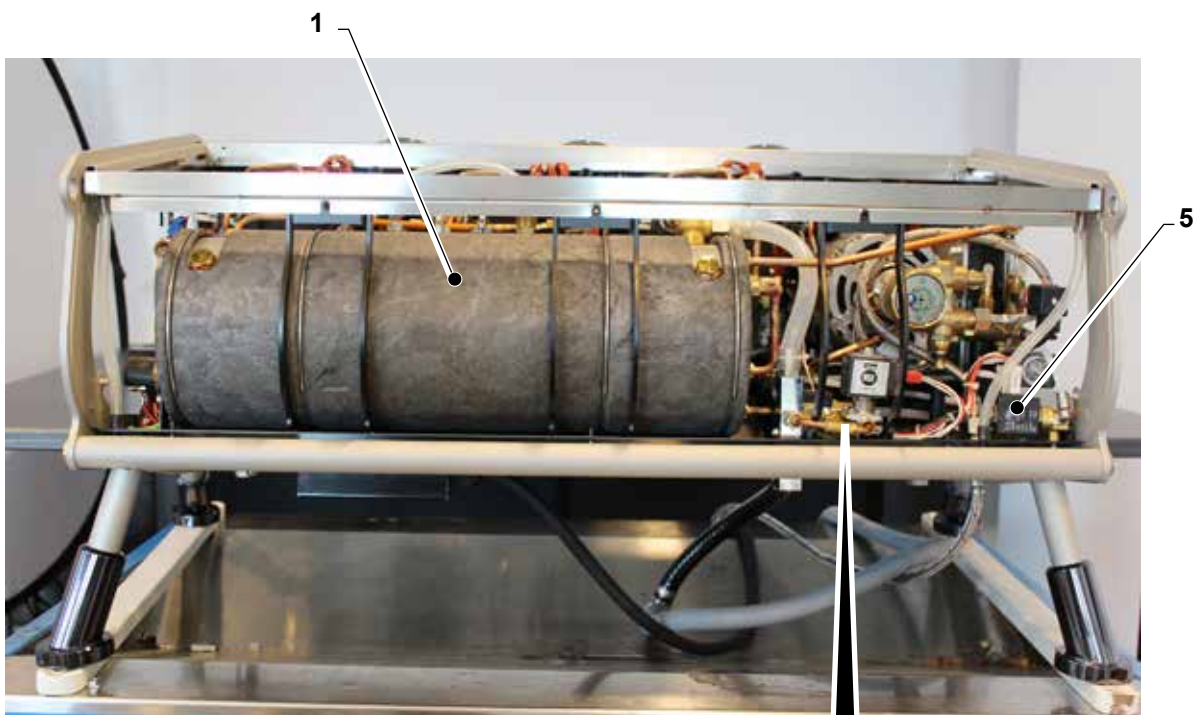

IT

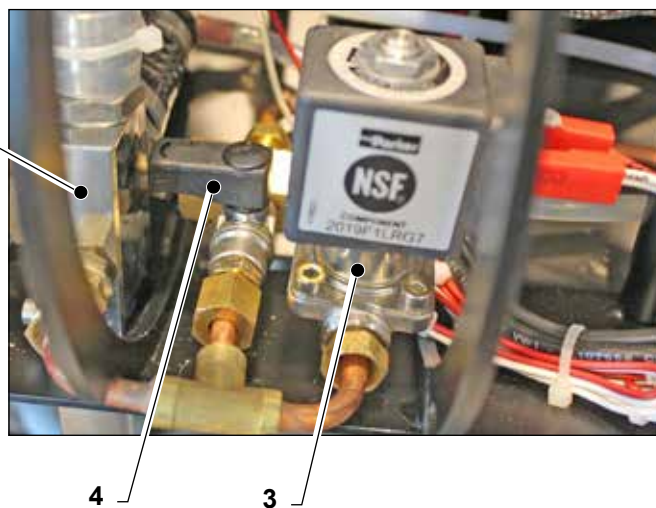

5.3 Vista laterale sinistra

- 1) Massello di carico
- 2) Trasduttore di pressione pompa
- 3) Elettrovalvola carico acqua
- 4) Piastra led
- 5) Centraline elettronica principale
- 6) Scheda espansione preinfusione
- 7) Interruttore accensione/spegnimento led laterali e anteriori

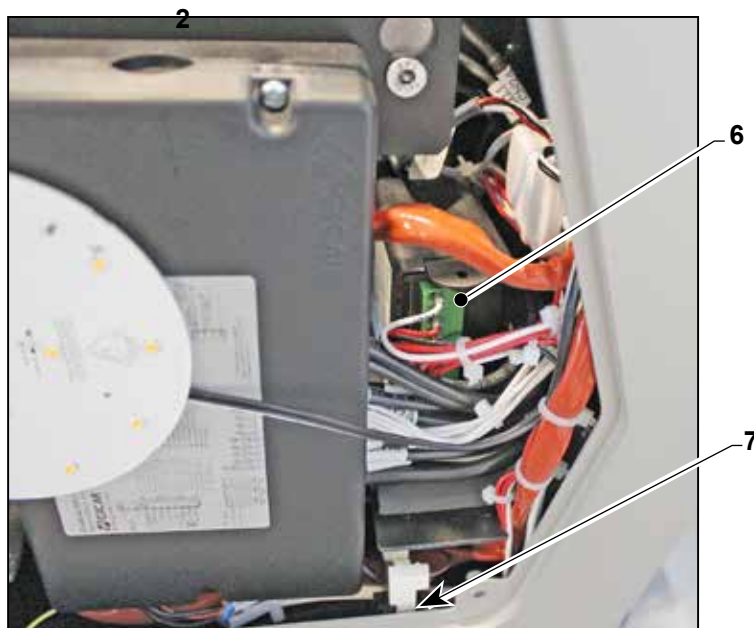
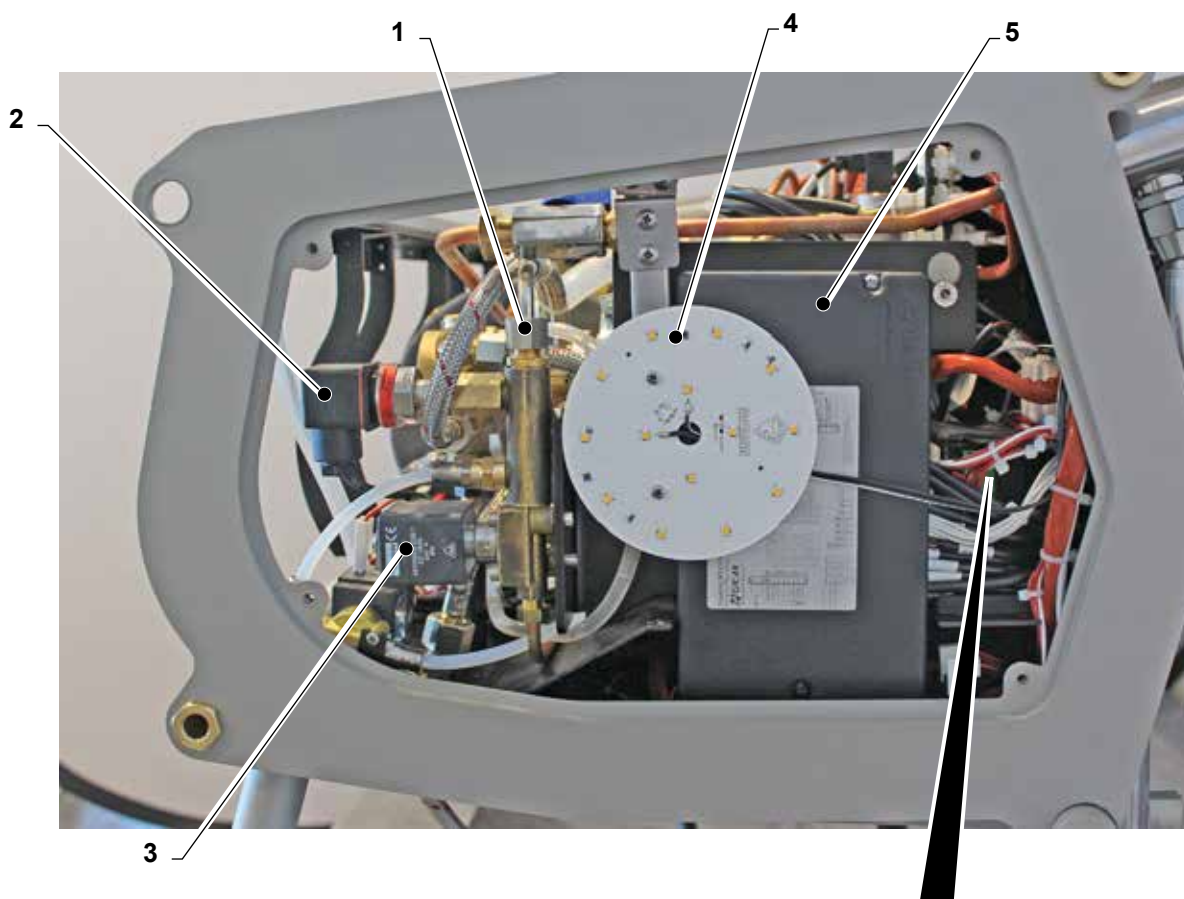

IT

5.4 Vista laterale destra

- 1) Connessioni scarico "Purge"
- 2) Pulsante "Purge"
- 3) Elettrovalvola "Purge"
- 4) Valvola di espansione
- 5) Piastra led
- 6) Resistenze boiler

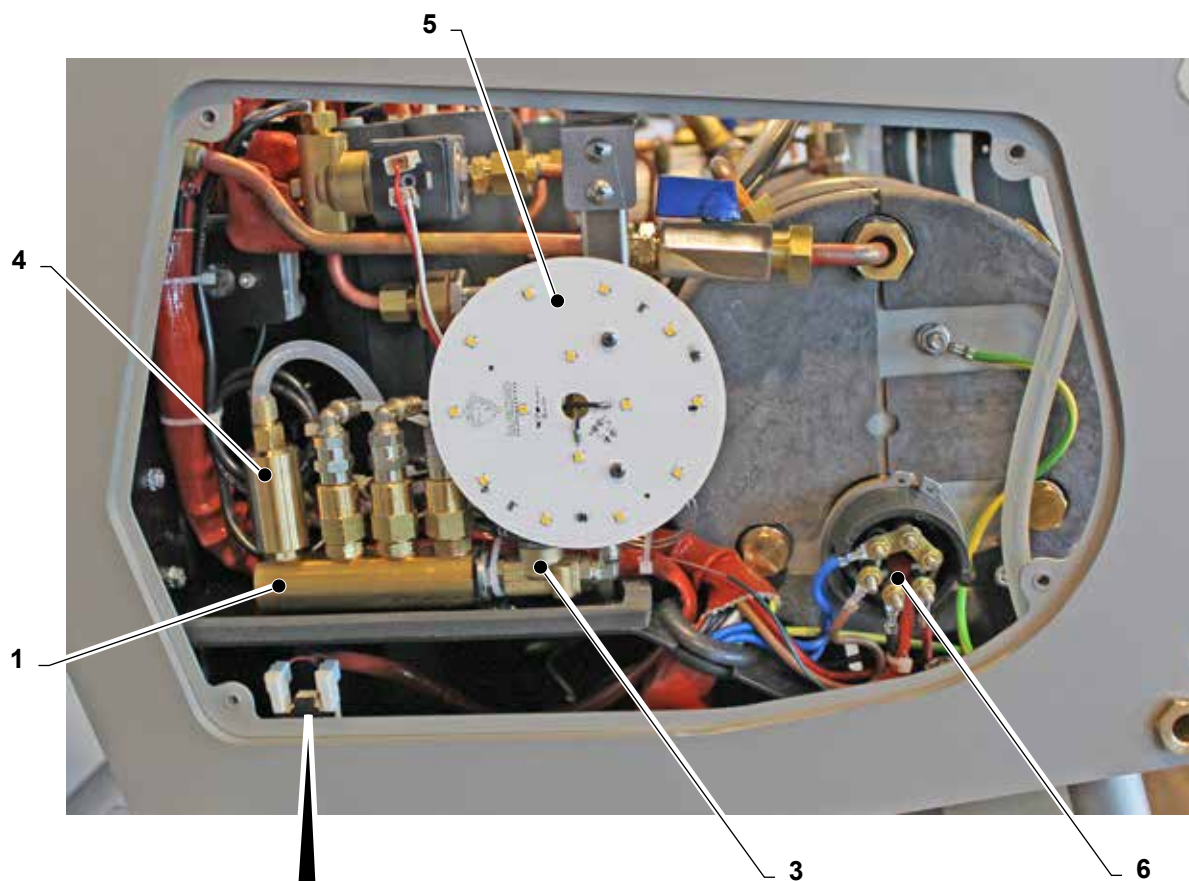

IT

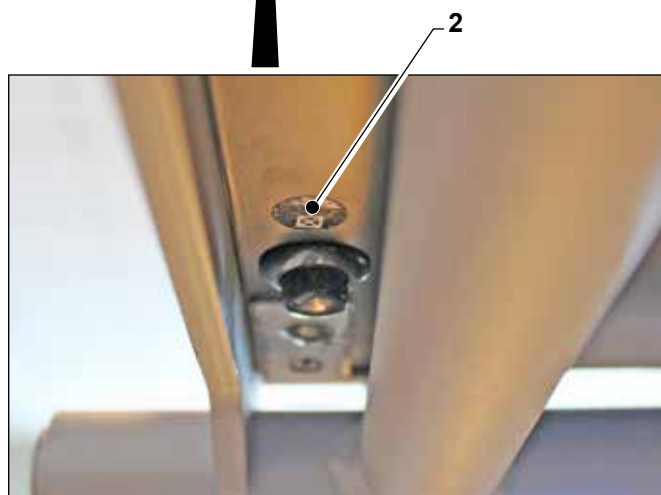

5.5 Rimozione pannello elettrico

Rimuovere il pannello anteriore inferiore come descritto nel relativo paragrafo

- Svitare i due pomelli (1) posizionati sotto la parte frontale della macchina.



- Estrarre il pannello elettrico (2).

5.6 Topografia pannello elettrico

- 1) Relè di potenza
- 2) Scheda triac (riscaldamento gruppi e preriscaldamento caldaie)
- 3) Connettore autocentrante alta tensione
- 4) Relè statici monofase controllo riscaldamento caldaia vapore
- 5) Condensatore
- 6) Scheda interfaccia WIFI (opzionale)
- 7) Ventola raffreddamento alimentatore
- 8) Alimentatore switching (trasformatore stabilizzato)
- 9) Fusibile "F2" 3,15 A - Fusibile leds
- 10) Fusibile "F1" 1 A - Fusibile centralina

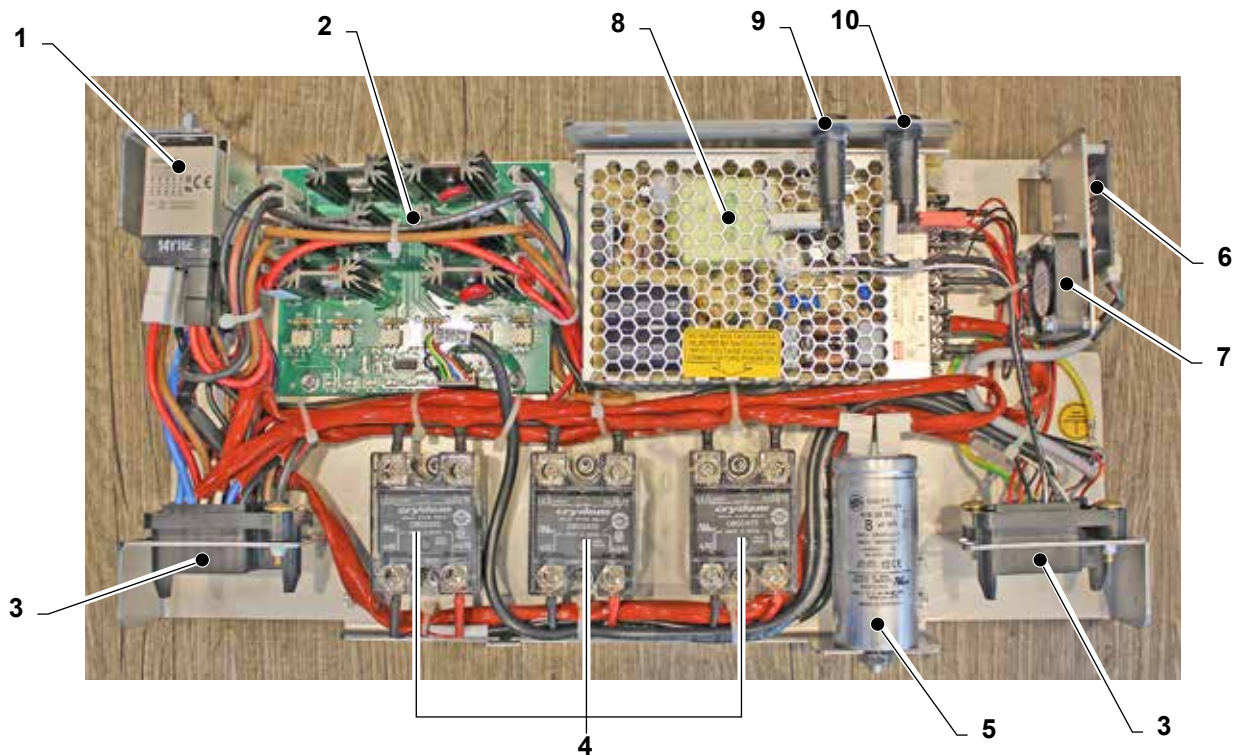
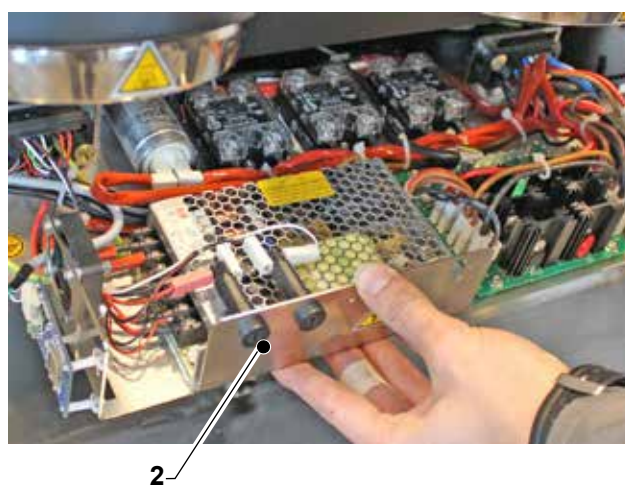

IT

6. REGOLAZIONI E RIPRISTINI

6.1 Regolazione Acqua miscelata

- Agire sulla vite (1) dell'elettrovalvola acqua miscelata, posizionata nella parte inferiore posteriore sinistra, per regolare la quantità di acqua fredda che si miscela con quella calda durante l'erogazione dell'acqua.



6.2 Spurgo aria dal circuito

- Premere il pulsante (1), posizionato nella parte inferiore anteriore destra, per eccitare le bobine e scaricare l'aria eventualmente presente nel circuito.
- Tenere premuto il pulsante fino a che dallo scarico si sente uscire solo acqua e non acqua e aria.

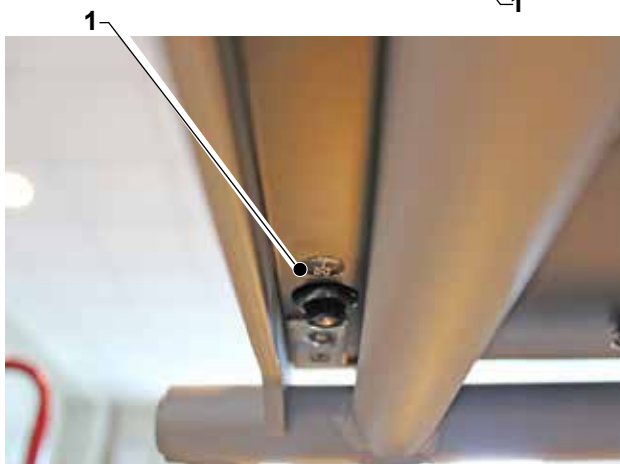

6.3 Ripristino termostato di sicurezza caldaia servizi

- Rimuovere il pannello laterale destro come indicato nel relativo paragrafo.
- Premere il termostato di sicurezza (1) per riarmarlo.

IT



**Se dopo aver riarmato il termostato di sicurezza, al riavvio della macchina, il termostato si rince-
risce nuovamente è necessario
controllare le resistenze del boiler e gli altri termostati presenti in
macchina.**

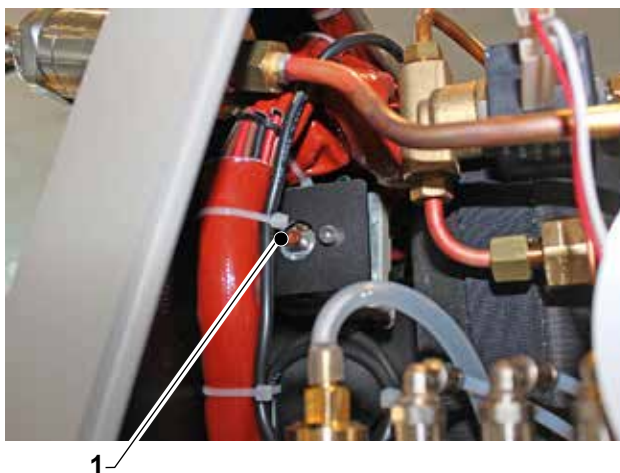

6.4 Ripristino termostato di sicurezza caldaiette

- Rimuovere lo scaldatazze come indicato nel relativo paragrafo.
- Premere il termostato di sicurezza (1) per riarmarlo.

 **Se dopo aver riarmato il termostato di sicurezza, al riavvio della macchina, il termostato si riscalda nuovamente è necessario controllare la regolazione del termostato temperatura caldaietta o il suo corretto funzionamento.**

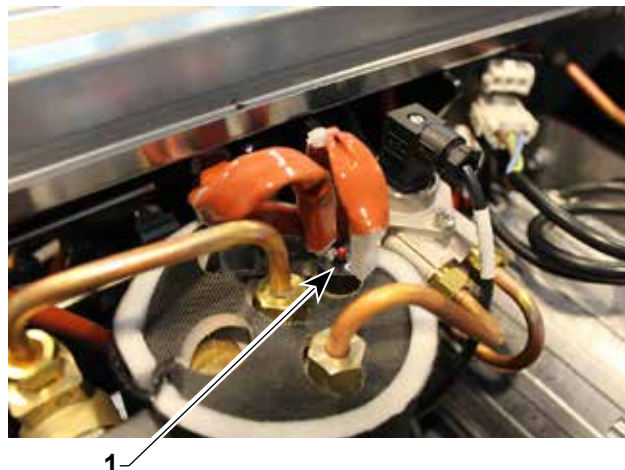

6.5 Ripristino termostato di sicurezza gruppo

- Rimuovere i carter del gruppo come indicato nel relativo paragrafo.
- Premere il termostato di sicurezza (1) per riarmarlo.

 **Se dopo aver riarmato il termostato di sicurezza, al riavvio della macchina, il termostato si riscalda nuovamente è necessario controllare la regolazione del termostato temperatura caldaietta o il suo corretto funzionamento.**



7. RIMOZIONI E SOSTITUZIONI

7.1 Sostituzione resistenza scaldatazze

- Rimuovere il piano scaldatazze come descritto nel relativo paragrafo.
- Svitare il dado (1) di collegamento filo di massa.

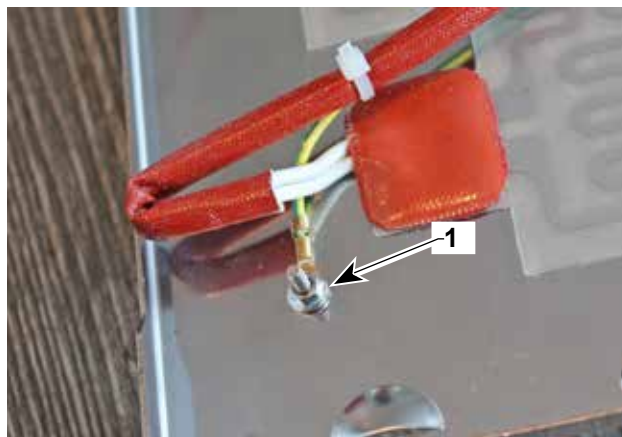

- Con una spatola rimuovere la resistenza adesiva (2).
- Pulire il piano dai residui di colla.
- Riavvitare il dado di massa e in modo graduale applicare la resistenza (2) sul piano in modo che non vi siano bolle d'aria tra il piano e la resistenza.

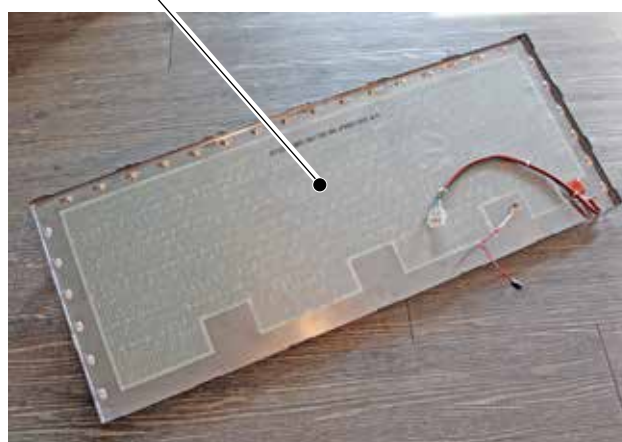

7.2 Sostituzione sonda scaldatazze

- Rimuovere il piano scaldatazze come descritto nel relativo paragrafo.
- Svitare il dado (1) e rimuovere la piastrina di fermo (2).

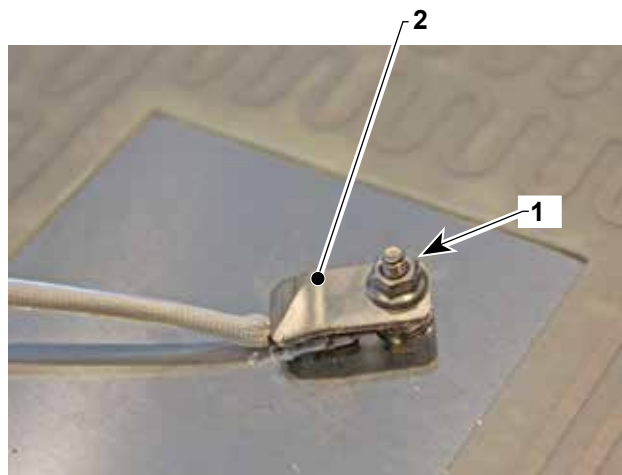

- Svitare il dado (3) e rimuovere la sonda (4).

 **Al rimontaggio spalmare una pasta conduttiva tra la sonda e il piano scaldatazze.**

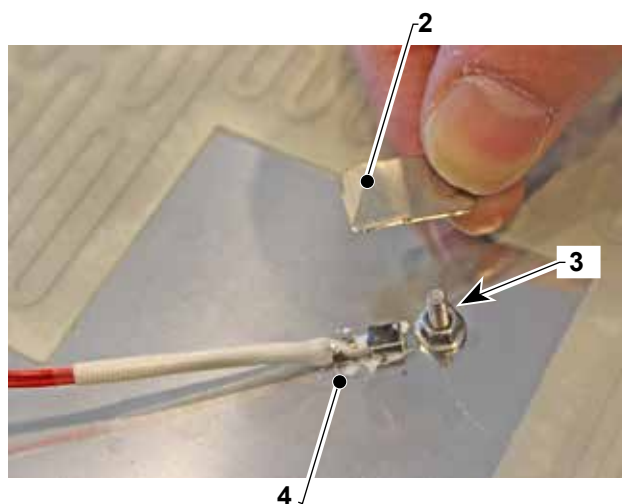

IT

7.3 Sostituzione resistenza caldaietta

! Togliere tensione alla macchina spostando su OFF l'interruttore centrale posto a monte.

- Rimuovere il carterino gruppo come descritto nel relativo paragrafo.
- Rimuovere il pannello frontale inferiore come descritto nel relativo paragrafo.
- Accertarsi che la macchina sia spenta e che il rubinetto di alimentazione idrica sia chiuso.
- Scaricare il circuito caffè aprendo il rubinetto (1) relativo al gruppo della caldaietta.

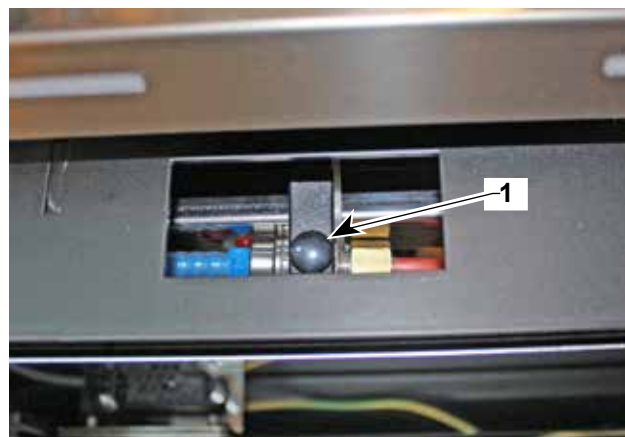

- Scollegare i due faston (2) dalla resistenza (3).

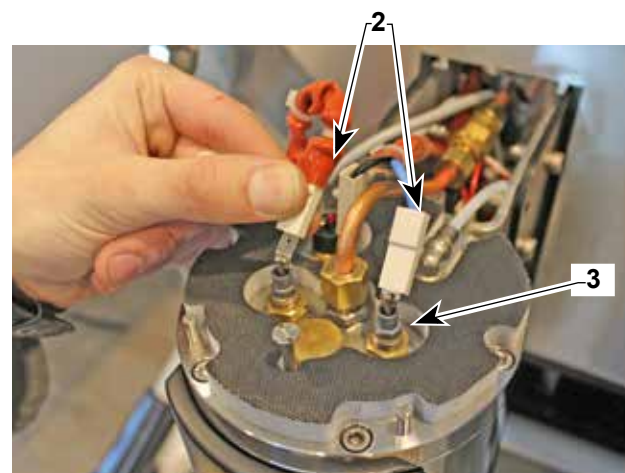

- Scollegare il tubetto (4) di scarico acqua; premere la ghiera e tirare il tubetto.

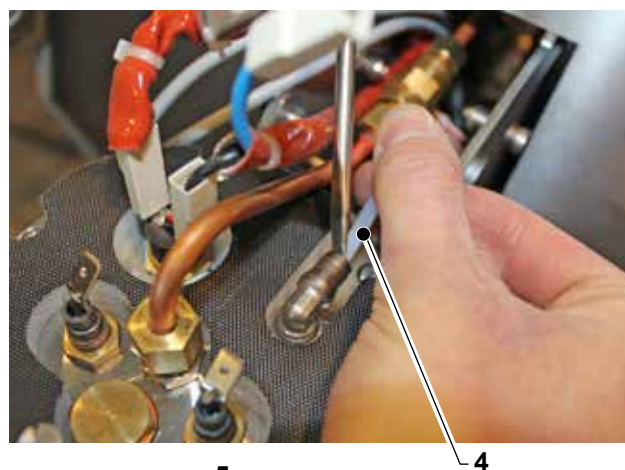

- Svitare il dado (5) del tubo di alimentazione acqua.

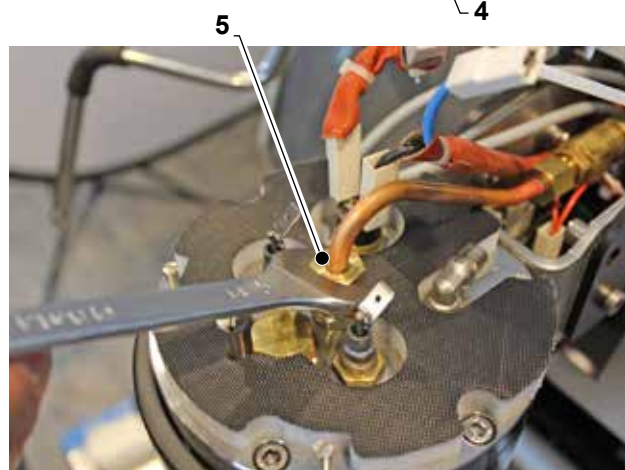

IT

- Svitare le viti (6) di fissaggio coperchio caldaietta.

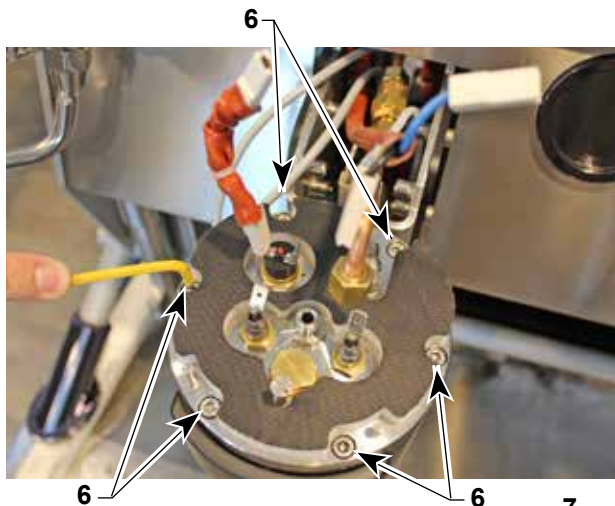

- Con un martello in plastica picchettare il coperchio (7) per facilitare la rimozione.

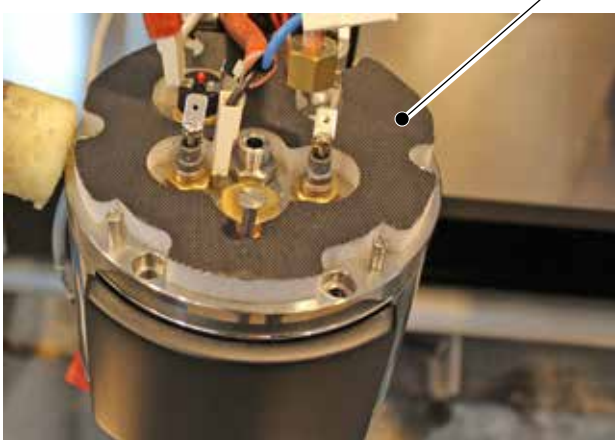

- Rimuovere il coperchio (7) .



- Svitare i dadi (8) e sostituire la resistenza (9).

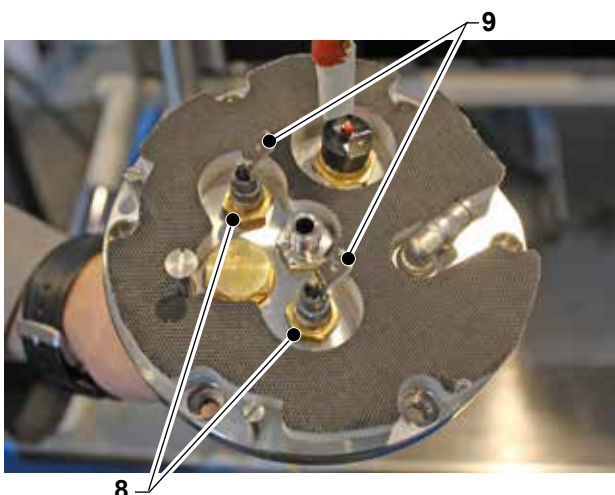

IT



Rimontare il tutto procedendo in senso inverso controllando lo stato della guarnizione (10), se rovinata sostituire. Controllare il corretto collegamento elettrico della resistenza e del termostato di sicurezza.



7.4 Sostituzione termostato caldaietta

- Rimuovere il coperchio caldaietta (1) come descritto nel paragrafo “Sostituzione resistenza caldaietta”.
- Svitare il dado (2) e rimuovere il termostato (3).



Al rimontaggio spalmare con una pasta conduttiva le superfici di contatto del termostato (3) con il coperchio (1).

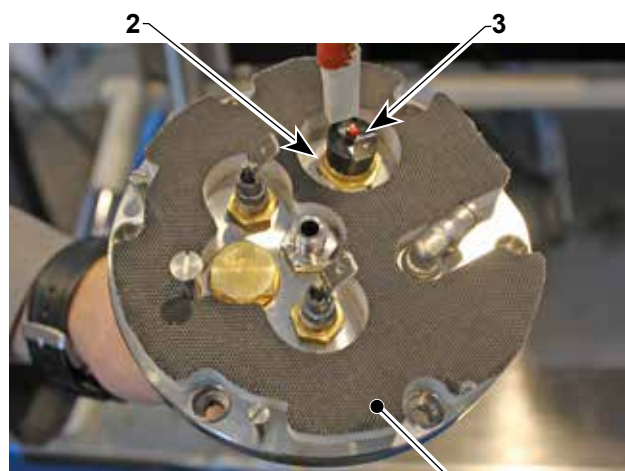

7.5 Sostituzione caldaietta gruppo.

- Rimuovere lo scaldatazze e il pannello anteriore frontale come indicato nei relativi paragrafi.
- Scaricare il circuito caffè relativo alla caldaietta da rimuovere aprendo il relativo rubinetto (1).

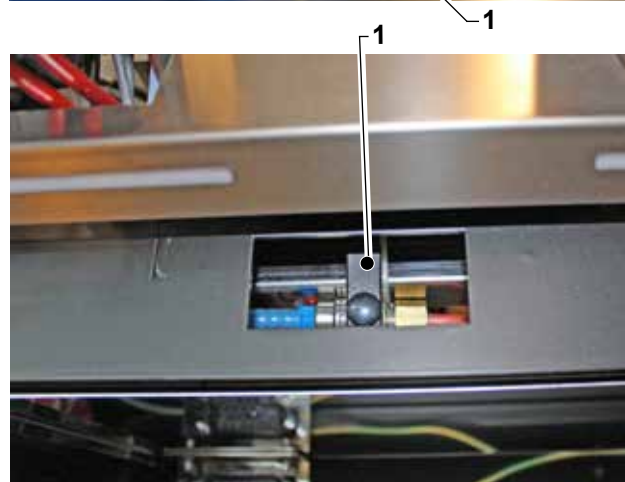

IT

- Scollegare i collegamenti elettrici (2) della calda-
iatta. (3).

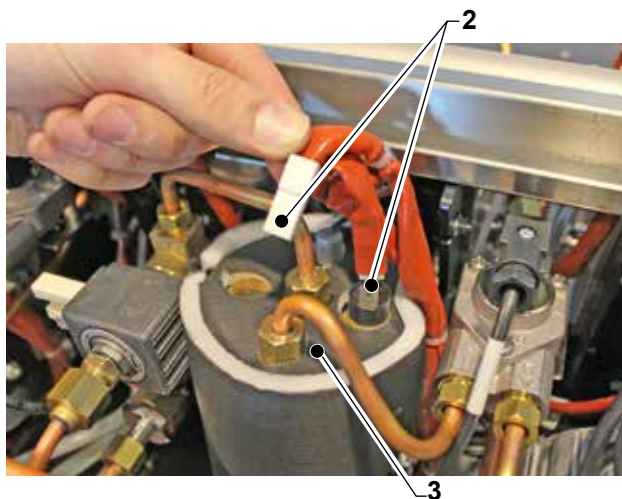

- Scollegare il connettore (4) di collegamento son-
da.

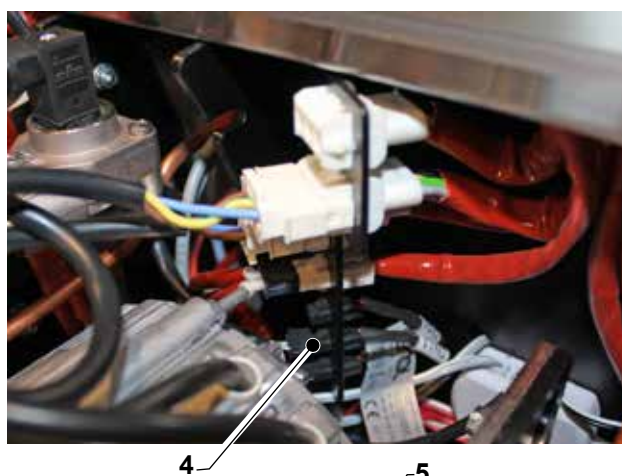

- Svitare i due tubi (5) di collegamento acqua.

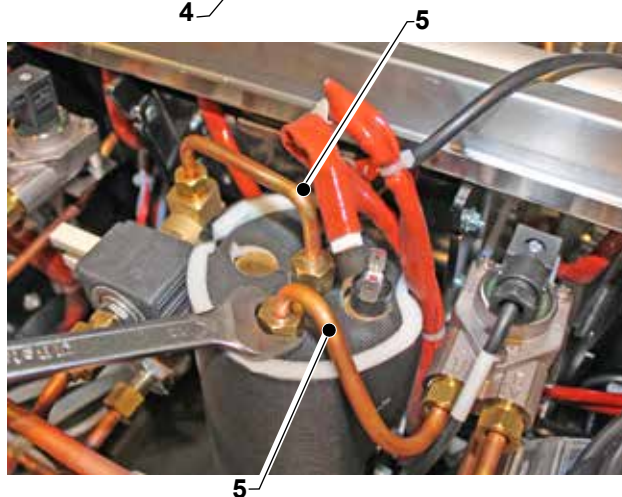

- Allentare i dadi (6) sollevarla e sganciarla dalla
staffa di sostegno (7).

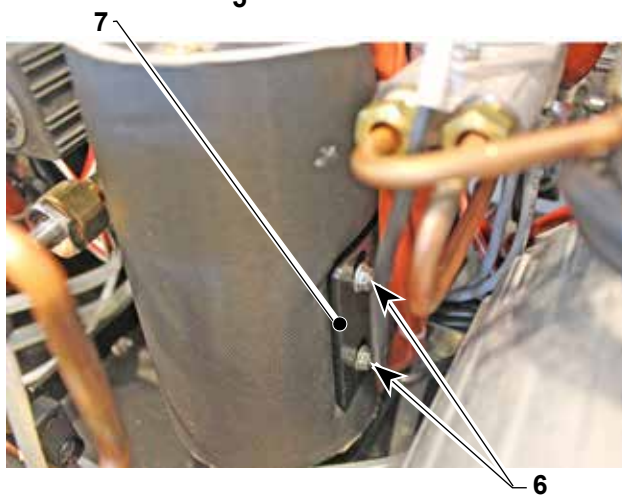

IT

- Scollegare i connettori (8) della resistenza e svitare il dado (9) di collegamento rubinetto di scarico.
- Sostituire la caldaietta operando inversamente allo smontaggio ricollegando i cavi elettrici facendo riferimento allo schema elettrico allegato.

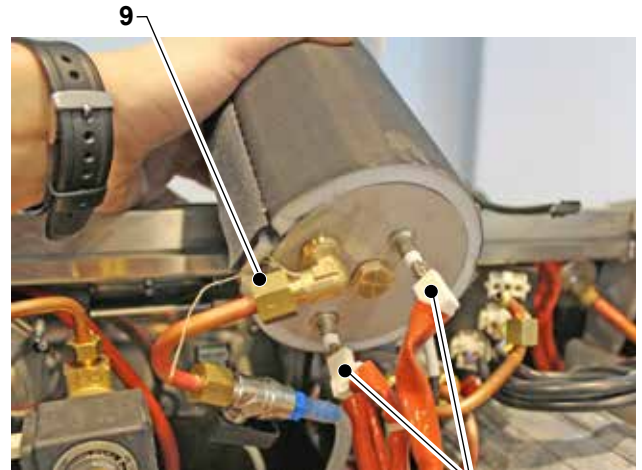

7.6 Sostituzione resistenza caldaia caffè



Togliere tensione alla macchina spostando su OFF l'interruttore generale posto a monte.

- Rimuovere il pannello laterale destro e lo scaldatasse come indicato nei relativi paragrafi.
- Aprire il rubinetto (1) per scaricare l'acqua presente nella caldaia (2).
- Scollegare tutti i fili che collegano la resistenza (3) al cablaggio macchina svitando i relativi dadi (4).

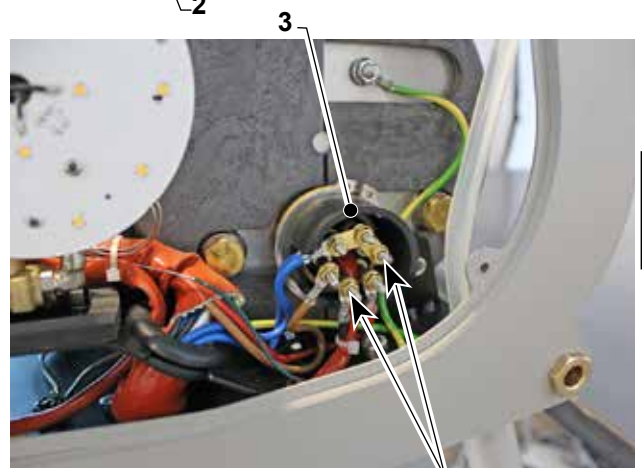
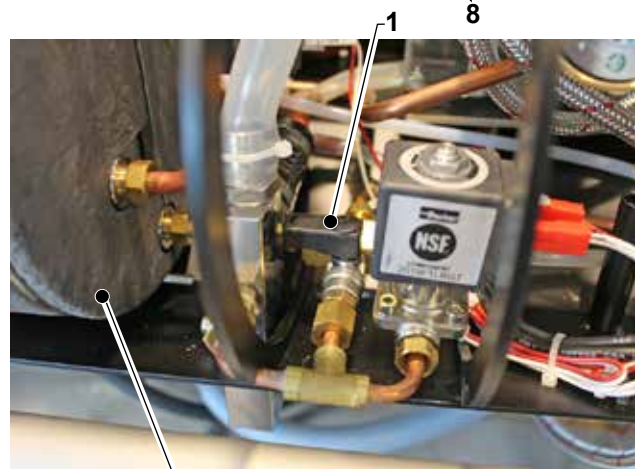

- Rimuovere il seeger (5) e la protezione (6).
- Rimuovere la resistenza (3).
- Rimontare il tutto procedendo in senso inverso allo smontaggio controllando lo stato della resistenza, se usurata sostituirla.
- Collegare il cablaggio seguendo le indicazioni riportate sullo schema elettrico allegato al presente manuale.

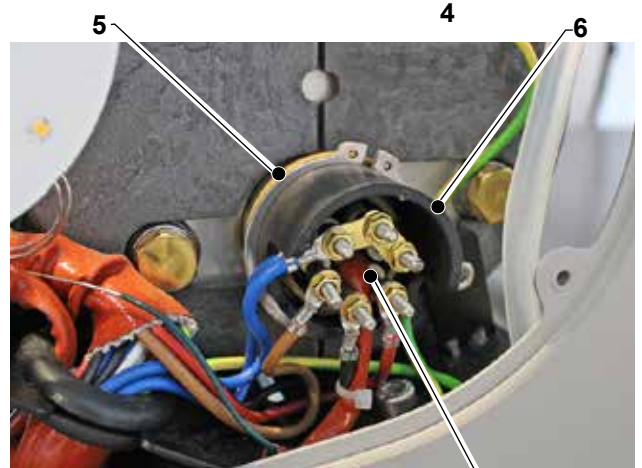

IT

7.7 Sostituzione pompa

- Rimuovere lo scaladatazze come indicato nel relativo paragrafo.
- Scollegare la pompa dai tubi svitando i dadi (1) e (2).

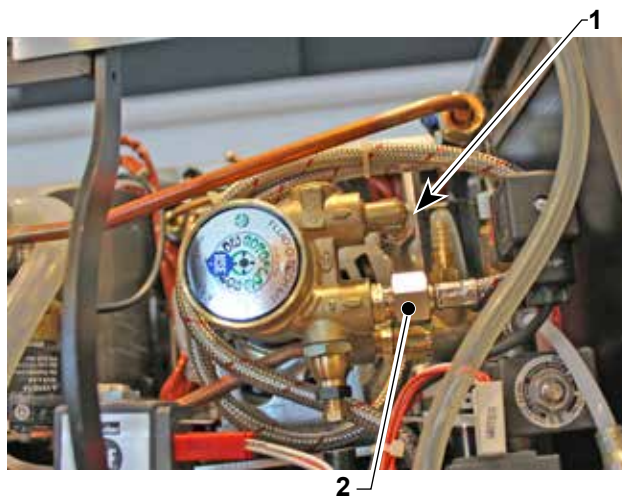

- Allentare la fascetta (3).

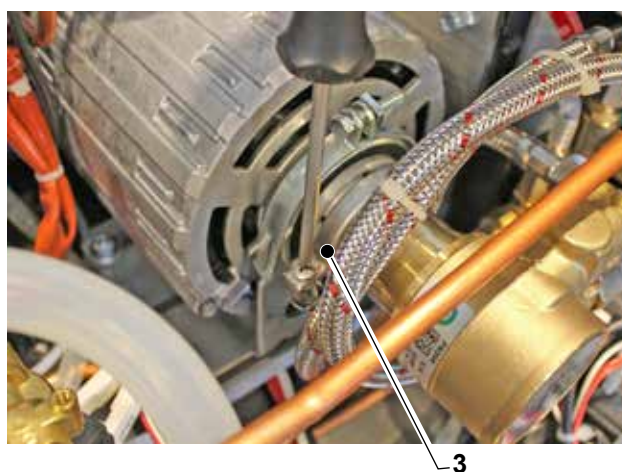

- Rimuovere la pompa completa (4): Al rimontaggio fare attenzione a incastrare correttamente il perno pompa sull'albero motore.

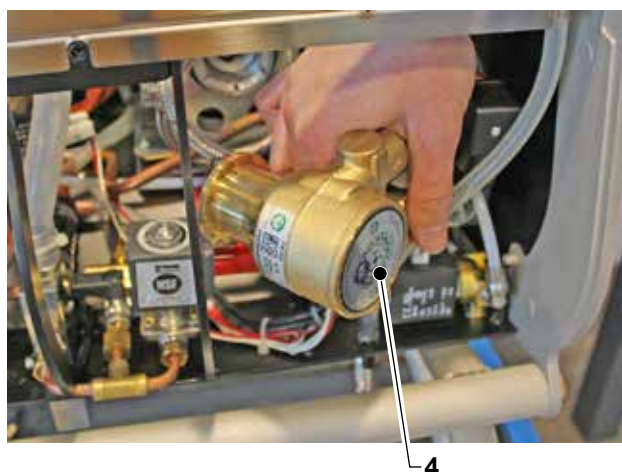

IT



Al rimontaggio fare attenzione a incastrare correttamente il perno pompa sull'albero motore.

7.8 Sostituzione motore pompa

- Rimuovere lo scaladatazze e il pannello laterale sinistro come indicato nei relativi paragrafi.
- Rimuovere la pompa come indicato nel relativo paragrafo senza scollegare i tubi di aspirazione e mandata.
- Svitare le due viti (1) e spostare la piastra led (2) con la relativa staffa (3).

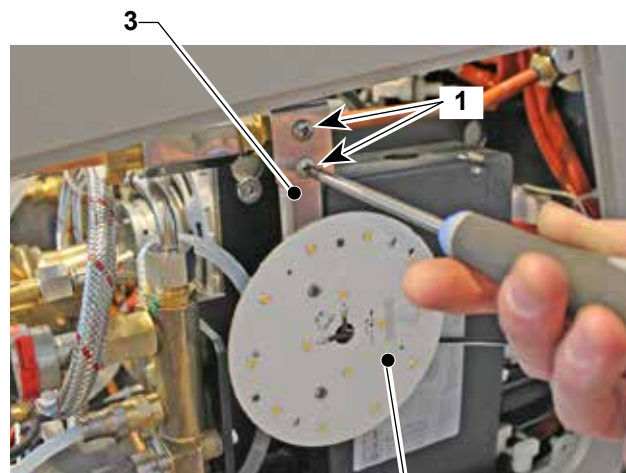

- Allentare le viti (4) di fissaggio pompa alla piastra (5).

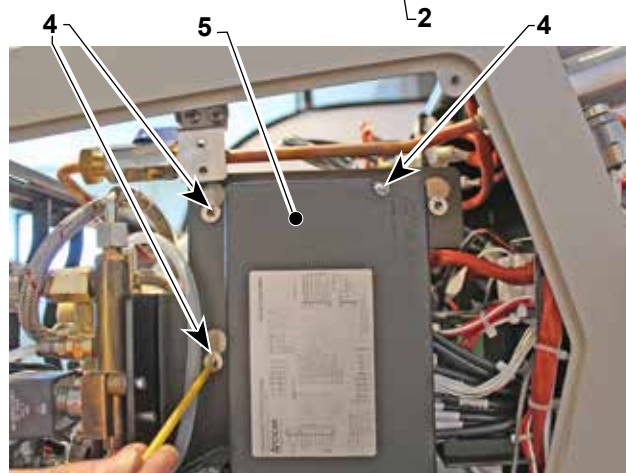

- Scollegare il due connettori (6) e (7) della pompa.

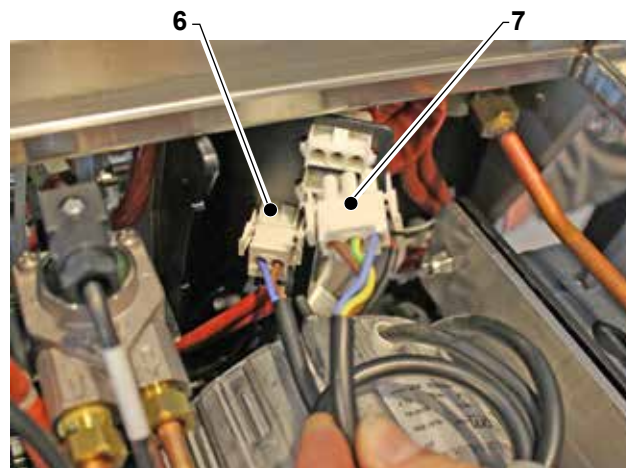

- Sollevare il motore pompa (8) sganciandolo dalla piastra (5) e rimuoverlo.
- Rimontare il tutto procedendo inversamente allo smontaggio facendo attenzione a collegare il connettore (7) sul connettore a 3 vie più in basso; fare riferimento anche allo schema elettrico.

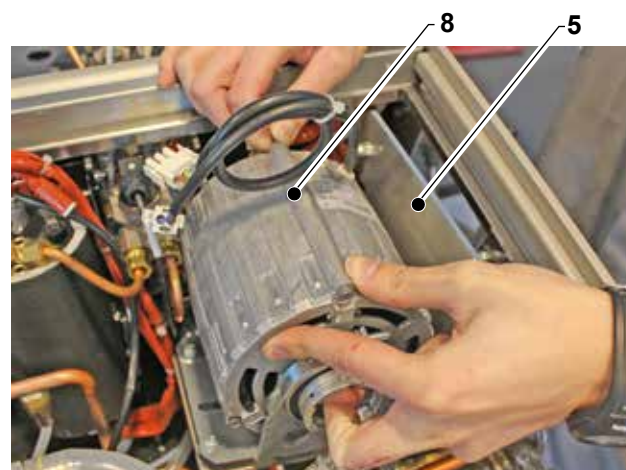

IT

7.9 Sostituzione piastra led.

- Togliere il pannello laterale come indicato nel relativo paragrafo.
- Svitare le due viti (1).

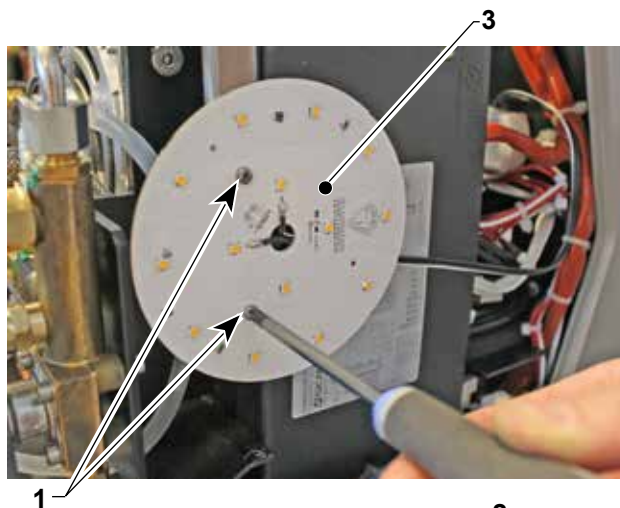

- Scollegare il connettore (2) dalla scatola di derivazione e sostituire la piastra completa (3).

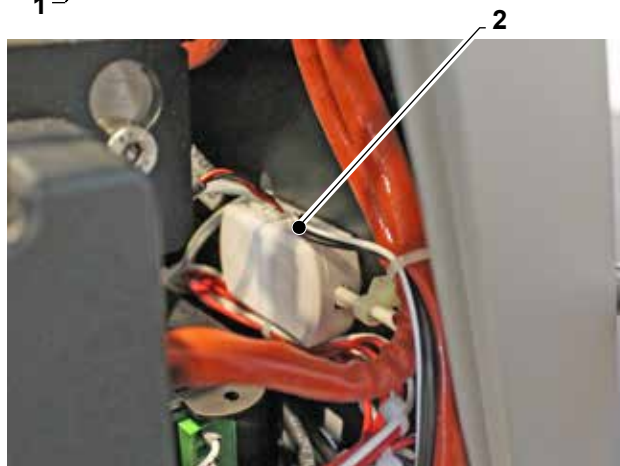

IT

7.10 Sostituzione elettrovalvola carico caldaia.

- Rimuovere il pannello laterale sinistro come indicato nel relativo paragrafo.
- Scollegare i due faston (1) dalla bobina (2).

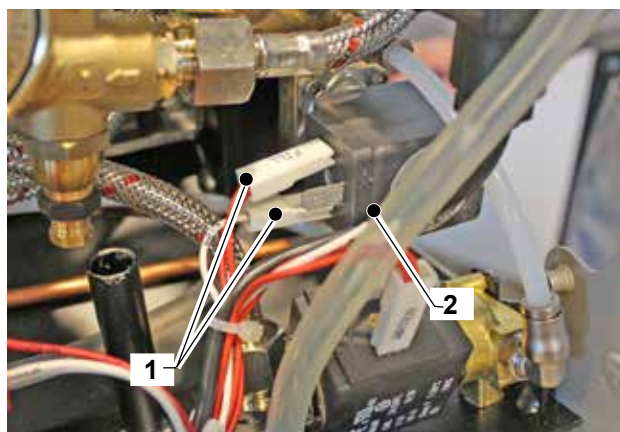

- Svitare il dado (3) della bobina (2).

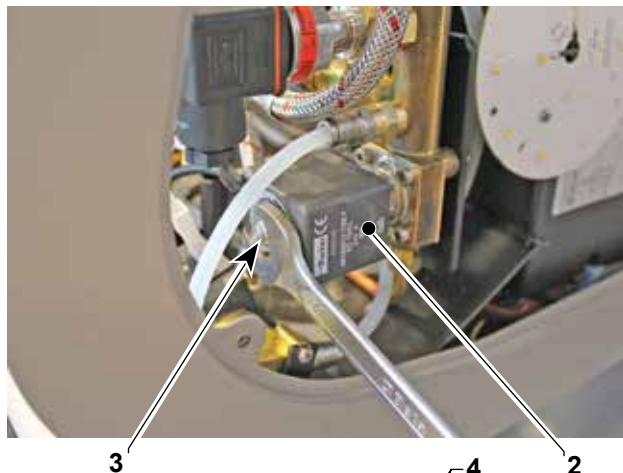

- Svitare le quattro viti (4) e togliere il nucleo (5) dell'elettrovalvola.
- Al rimontaggio fare attenzione a ricollegare correttamente i faston alla bobina.

 **Al rimontaggio del nucleo fare attenzione a rimontare correttamente la guarnizione, il nucleo e la molla.**

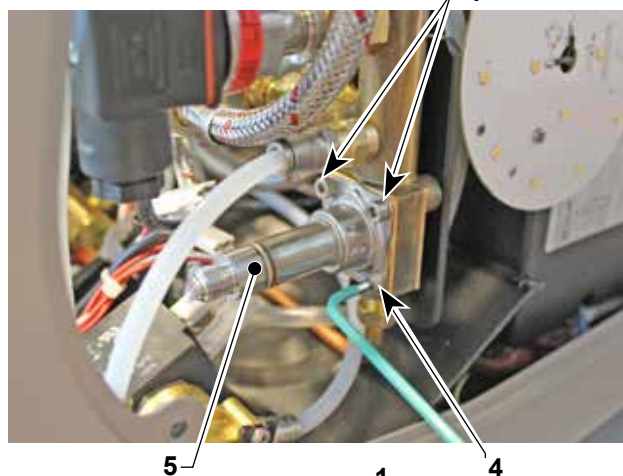

7.11 Sostituzione elettrovalvola acqua miscelata

- Rimuovere il pannello laterale sinistro, il fianco sinistro tubolare e il pannello posteriore come indicato nei relativi paragrafi.
- Svitare le due bussole (1).

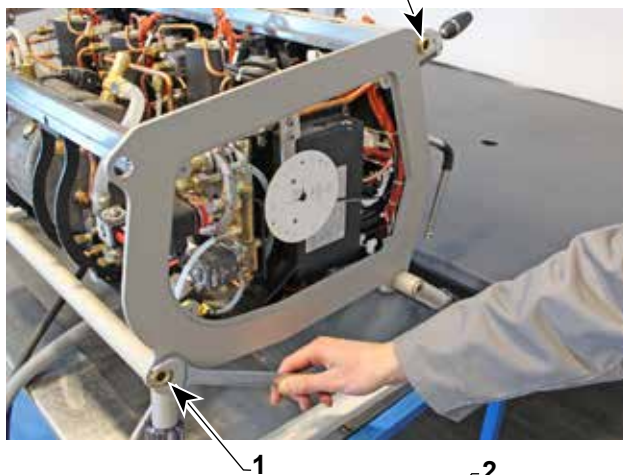

- Svitare la vite (2).



IT

- Rimuovere la spalla sinistra (3).

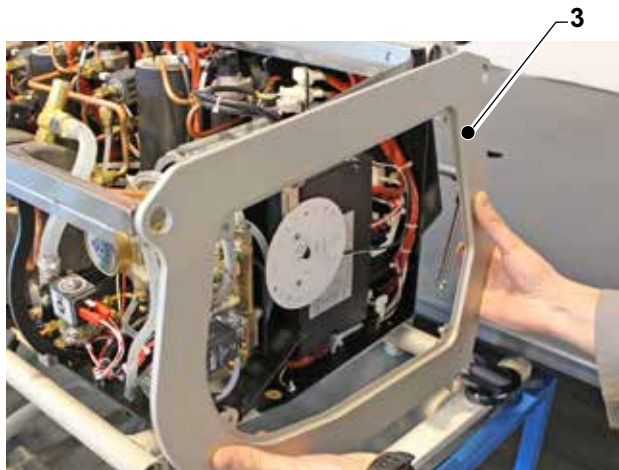

- Svitare le viti (4) di fissaggio elettrovalvola (5) alla staffa (6).

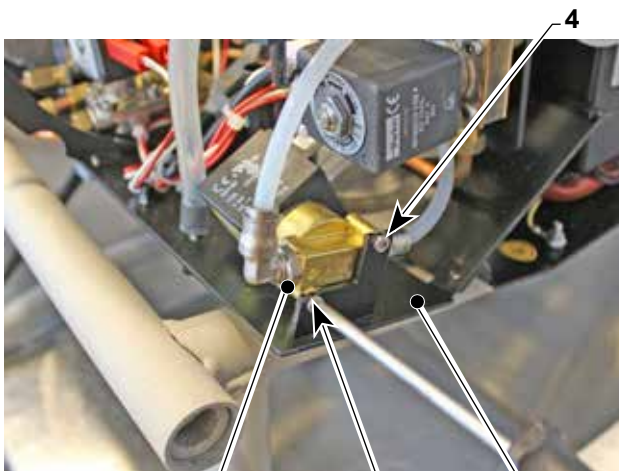

- Scollegare i due tubi (7) in Teflon.
- Scollegare i due faston (8).
- Per sostituire la bobina togliere la graffetta (9) o sostituire l'intera elettrovalvola (5).
- Al rimontaggio fare attenzione a ricollegare correttamente i faston alla bobina.

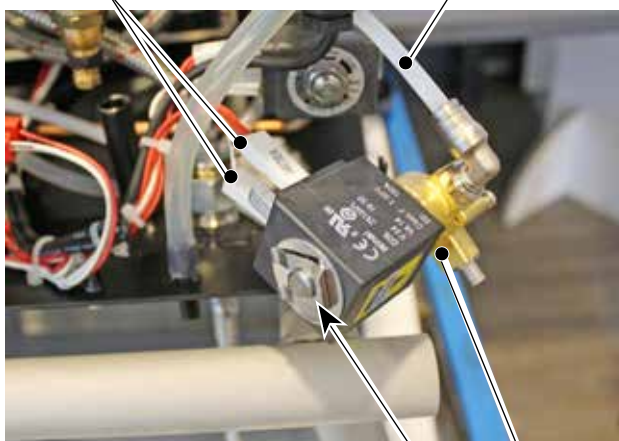

7.12 Sostituzione elettrovalvola acqua calda

- Rimuovere lo scaldabagno come indicato nel relativo paragrafo.
- Scollegare i faston (1).
- Svitare i due dadi (2) e rimuovere l'elettrovalvola (3).
- Sostituire o la bobina o l'elettrovalvola e rimontare inversamente allo smontaggio.

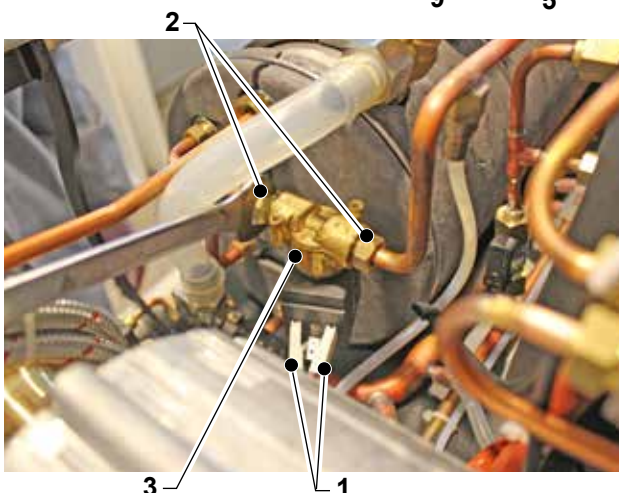

IT

7.13 Sostituzione elettrovalvola cooling cycle

- Rimuovere lo scaldatazze come indicato nel relativo paragrafo.
- Scollegare i faston (1).

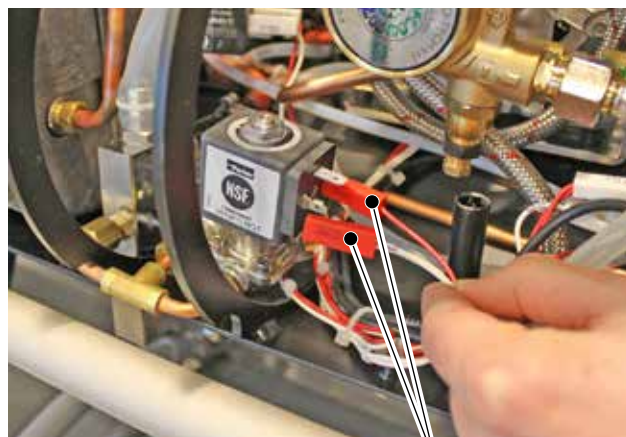

- Svitare il dado (2) e rimuovere la bobina (3).

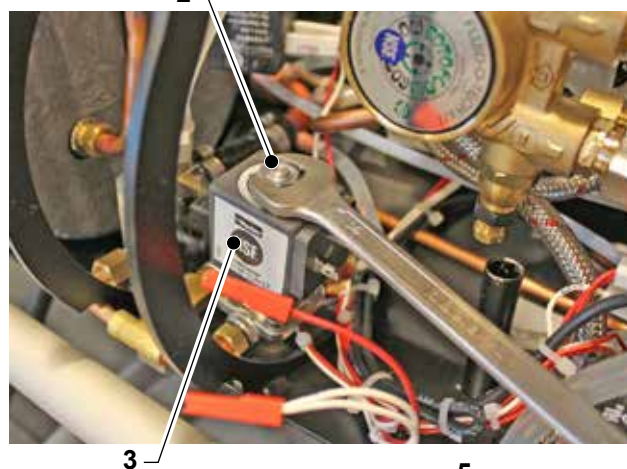

- Svitare le quattro viti (4) e rimuovere il nucleo (5).
- Al rimontaggio fare attenzione a ricollegare correttamente i faston alla bobina.

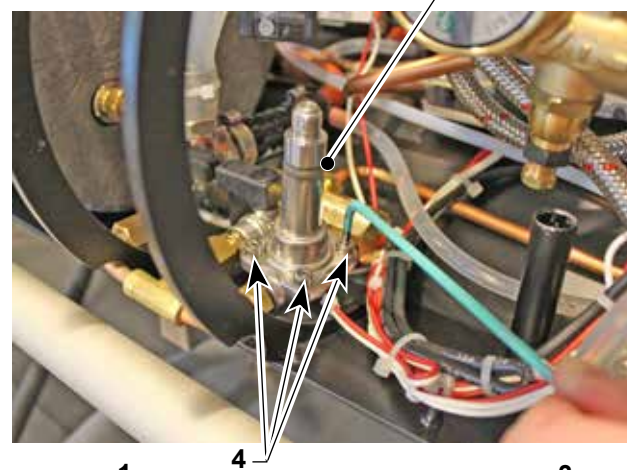

 **Al rimontaggio del nucleo fare attenzione a rimontare correttamente la guarnizione, il nucleo e la molla.**

7.14 Sostituzione elettrovalvola purge.

- Rimuovere il pannello laterale destro come indicato nel relativo paragrafo.
- Svitare le due viti (1) e spostare la piastra led (2) con la relativa staffa (3).

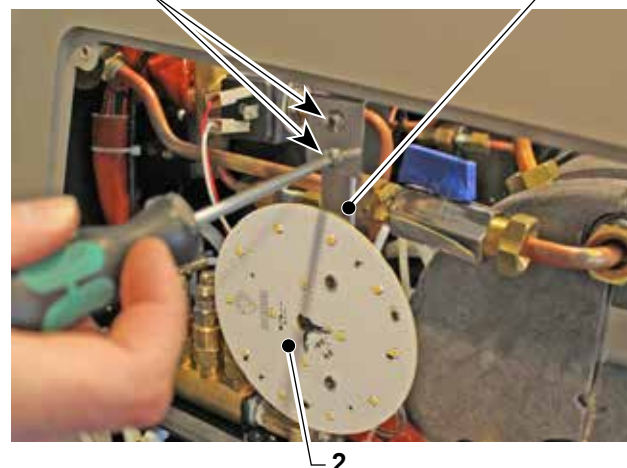

IT

- Tagliare la fascetta (4).



4

- Scollegare il tubo (5).



5

- Allentare il dado (6) che fissa il massello (7) alla staffa.

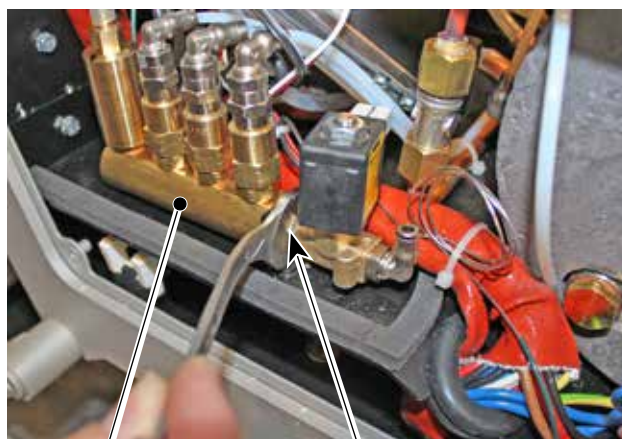

7

6

- Staccare i faston (8).

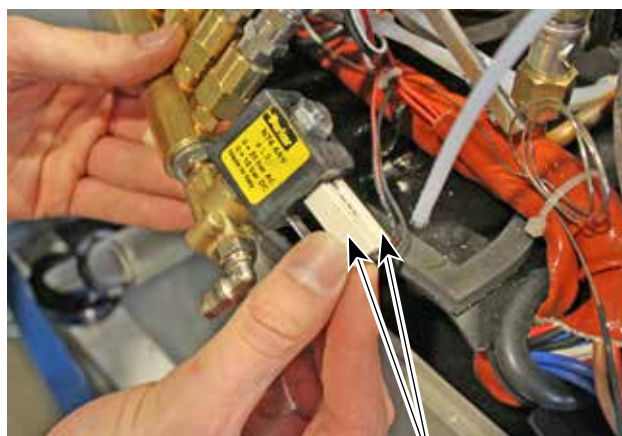

8

IT

- Con una chiave posizionata sul corpo elettrovalvola (9) svitarla dal massello (7).
- Al rimontaggio fare attenzione a ricollegare correttamente i faston alla bobina e mettere la fascetta nella posizione originale.

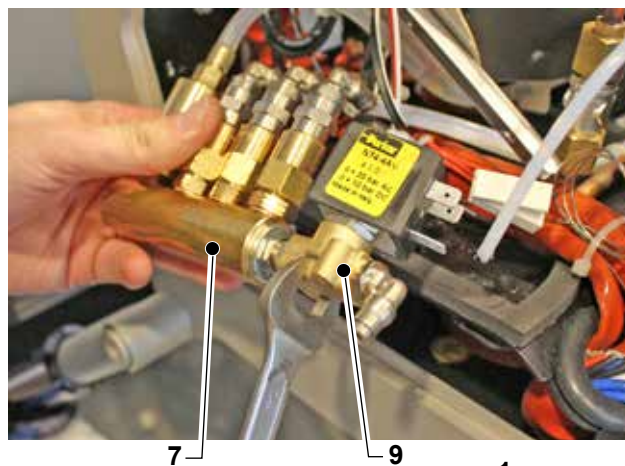

7.15 Sostituzione elettrovalvola preinfusione.

- Rimuovere lo scaldacanze come indicato nel relativo paragrafo.
- Staccare i faston (1).



- Svitare i tre dadi/raccordi (2) e rimuovere l'elettrovalvola (3).
- Al rimontaggio fare attenzione a ricollegare correttamente i faston alla bobina.
- Svitare i tre dadi/raccordi (2) e rimuovere l'elettrovalvola (3).
- Al rimontaggio fare attenzione a ricollegare correttamente i faston alla bobina.

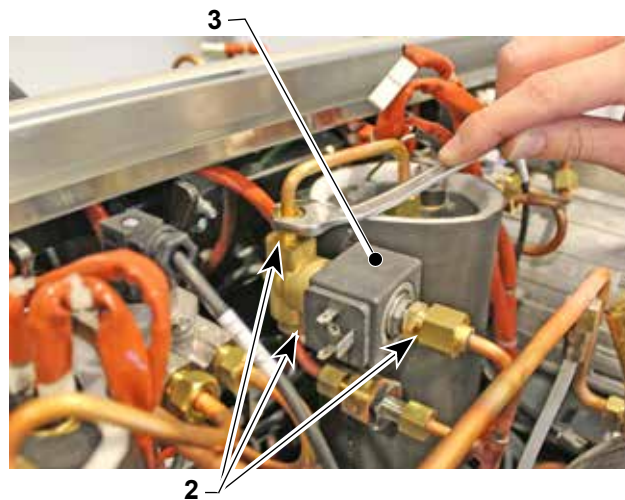

7.16 Sostituzione elettrovalvola gruppo

- Rimuovere i carterini gruppo come indicato nel relativo paragrafo.
- Con una pinza a becchi scollegare i faston (1).

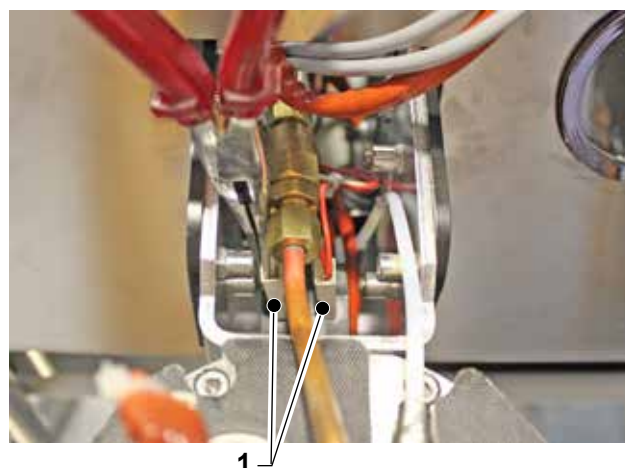

IT

- Aprire la fascetta a filo (2) e staccare il tubo (3).
- Svitare le quattro viti (4) e rimuovere il nucleo con la bobina (5).
- Al rimontaggio fare attenzione a ricollegare correttamente i faston alla bobina.

 **Al rimontaggio del nucleo fare attenzione a rimontare correttamente la guarnizione, il nucleo e la molla.**

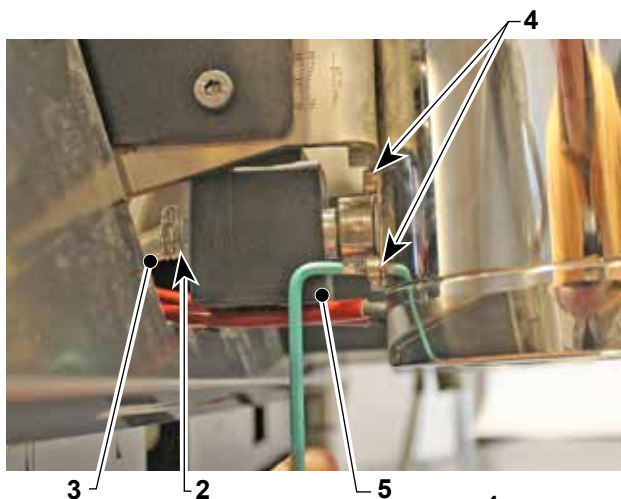

7.17 Sostituzione contatore volumetrico.

- Rimuovere lo scaldatazze come indicato nel relativo paragrafo.
- Svitare la vite (1) e rimuovere la testina (2).

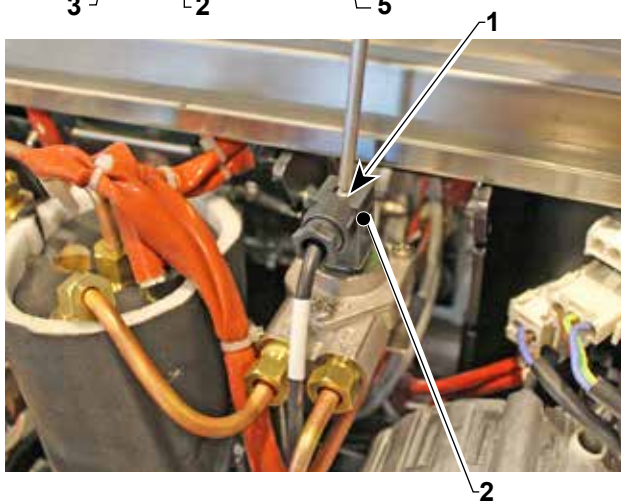

- Svitare i dadi (3) e staccare i tubi (4).

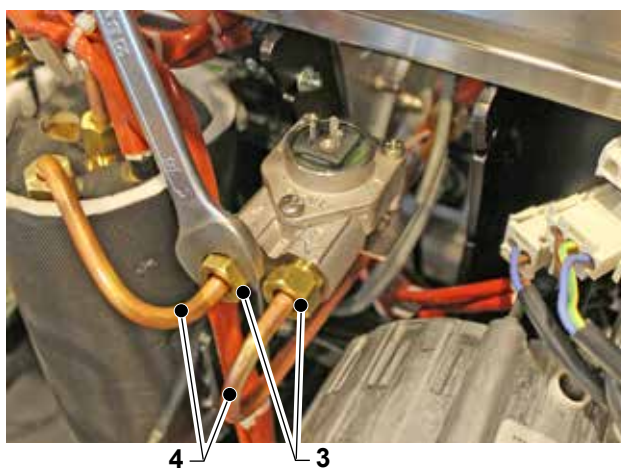

- Allentare i due dadi (5) posizionati sotto la squadretta di supporto, quindi sfilare il contatore volumetrico (6).

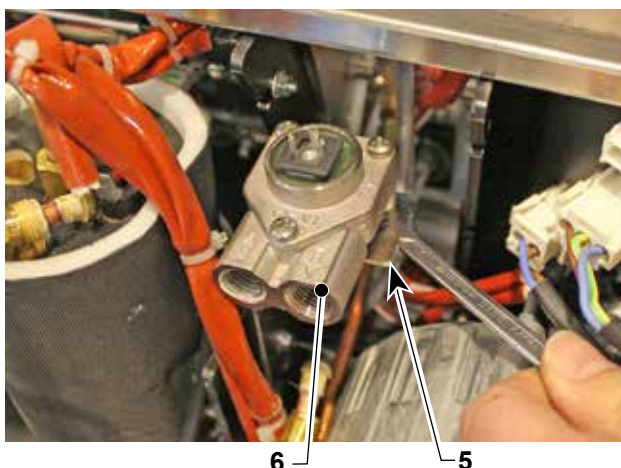

IT

7.18 Sostituzione trasduttore di pressione pompa

- Togliere il pannello sinistro come indicato nel relativo paragrafo.
- Tagliare le fascette (1) di fissaggio cavo trasduttore a al cablaggio macchina.

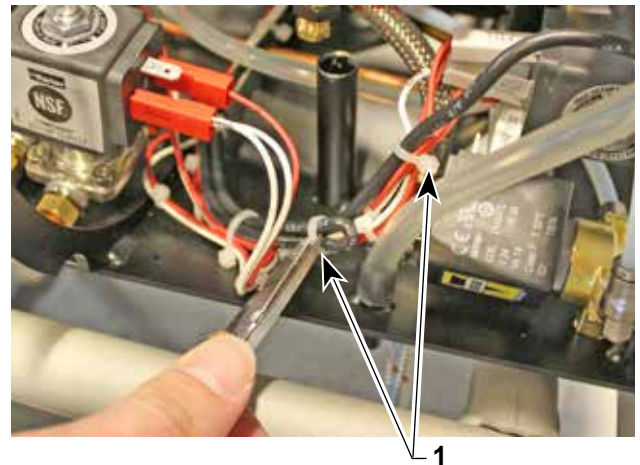

- Svitare il trasduttore (2) .

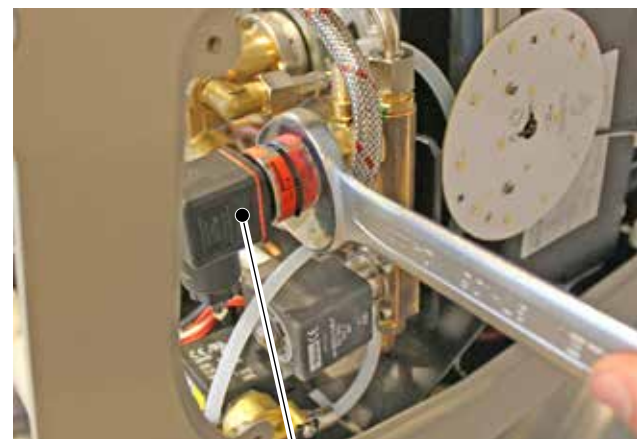

- Svitare la vite (3) e staccare i contatti (4) dal trasduttore (2).

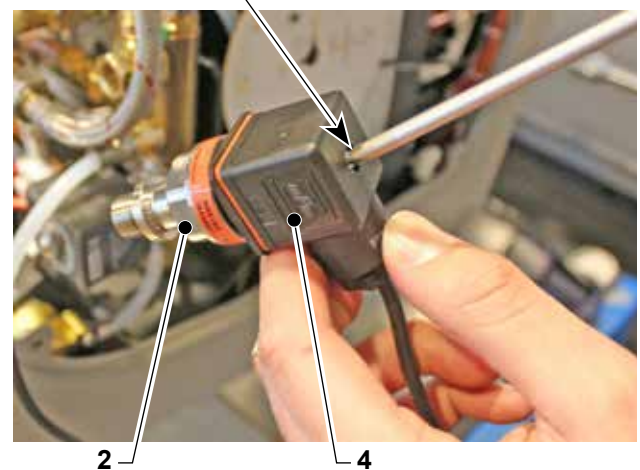

7.19 Sostituzione trasduttore di pressione caldaia servizi

- Rimuovere lo scaldatazze come indicato nel relativo paragrafo.
- Svitare il trasduttore (1) .
- Svitare la vite (2) e staccare i contatti (3) dal trasduttore (1).

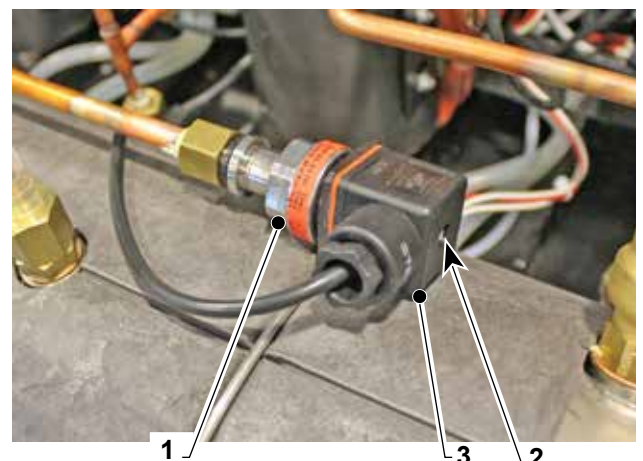

IT

7.20 Sostituzione scheda espansione preinfusione

- Rimuovere lo scaldabatte e il pannello laterale sinistro come indicato nei relativi paragrafi.
- Con un cacciavite lungo (1) a croce svitare le viti di fissaggio della scheda espansione

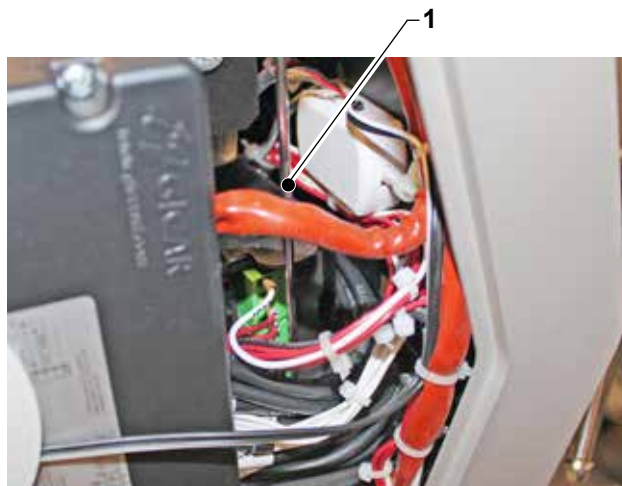

- Scollegare i connettori (2).

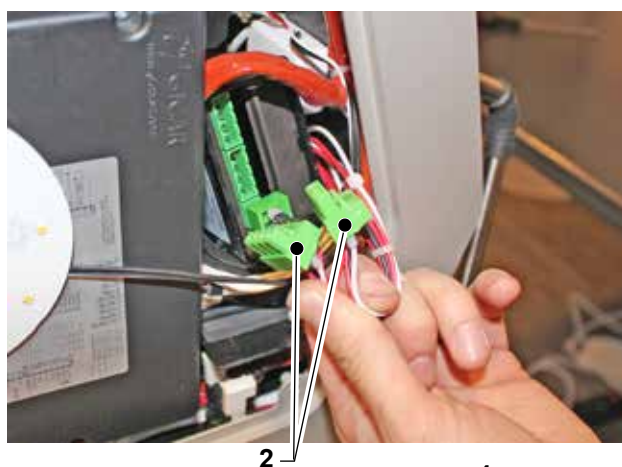

- Estrarre la scheda (3) e scollegare il connettore posteriore (4).



contrassegnare la posizione dei connettori in modo che al rimontaggio della scheda vengano inseriti nella rispettiva sede.

IT

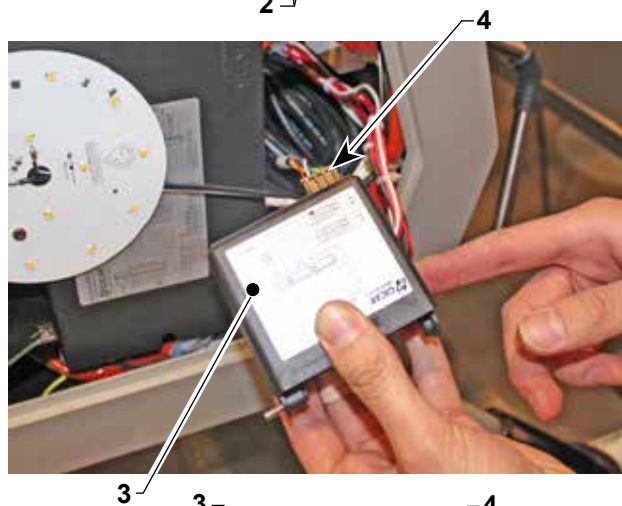

7.21 Sostituzione scheda elettronica

- Rimuovere il pannello laterale sinistro come indicato nel relativo paragrafo.
- Svitare le due viti (1) e spostare la piastra led (2) con la relativa staffa (3).

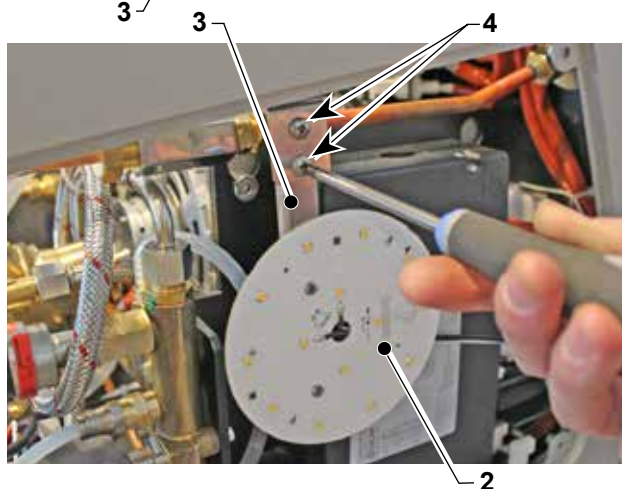

- Svitare le due viti (4) e rimuovere il coperchio (5) della scheda elettronica.

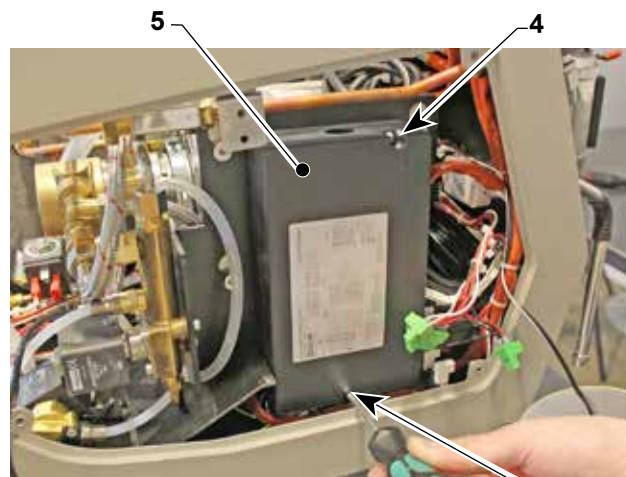

- Scollegare tutti i connettori della scheda (6), svitare i tre dadi flangiati (7) e rimuovere la scheda.

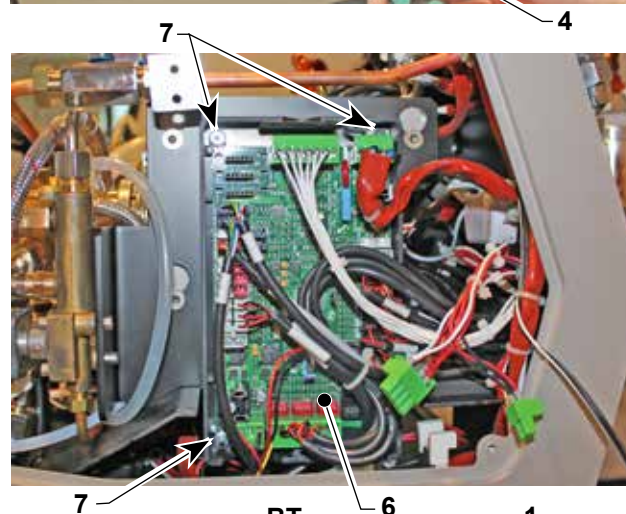

7.22 Sostituzione componenti pannello elettrico



Per il controllo è necessario che il collegamento elettrico sia inserito e quindi i componenti del pannello elettrico (4) siano alimentati.

Operare con estrema cautela.

- Per verificare il corretto funzionamento dei componenti del pannello elettrico è necessario estrarre lo stesso e collegare una apposita prolunga fornita a richiesta.
- Rimuovere il pannello frontale inferiore come descritto nel relativo paragrafo.
- Estrarre il pannello elettrico come indicato nel relativo paragrafo.
- Inserire la prolunga (1) al posto del pannello all'interno della macchina.
- Collegare il connettore siglato con "AT" al connettore (2), il connettore con siglato "BT" al connettore (3).

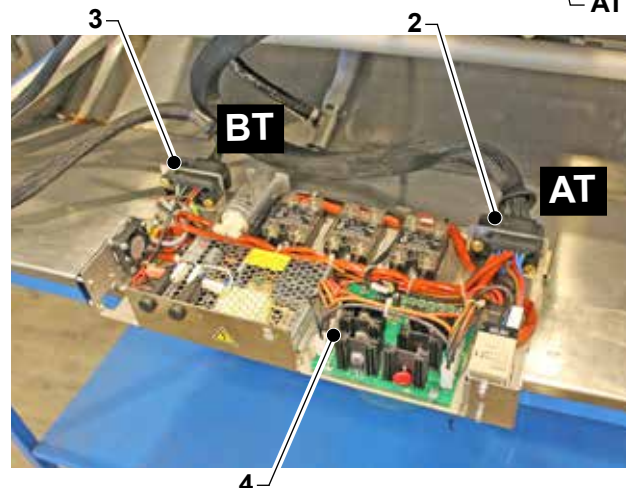
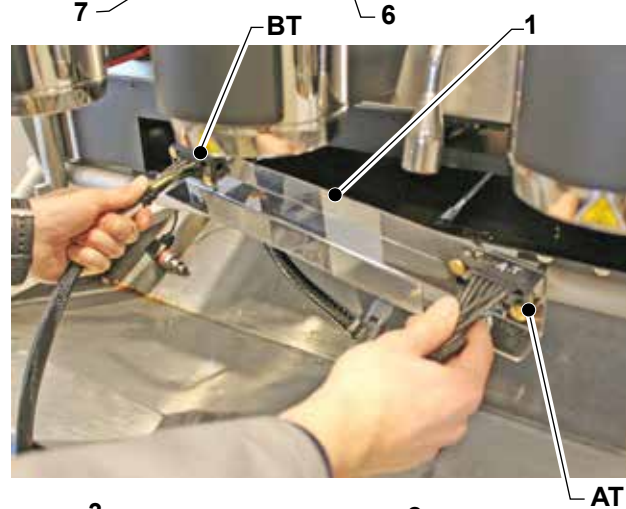

IT

- Se la piastra (5) è smontata montare i connettori come in figura facendo attenzione a posizionare la guida (6), per entrambe i connettori, così come è posizionata in figura.

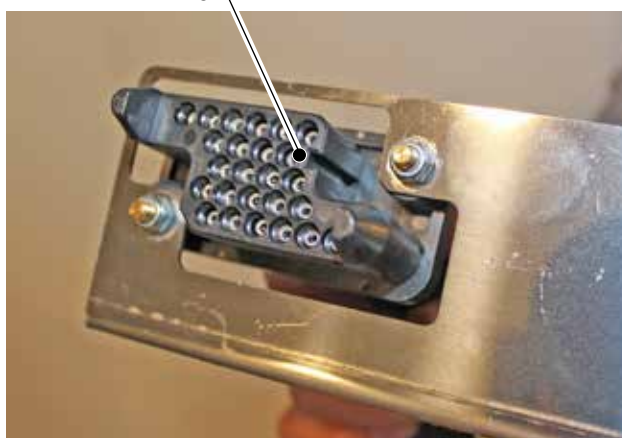

7.23 Sostituzione scheda display

- Rimuovere lo scaldacanze come indicato nel relativo paragrafo.
- Allentare i quattro dadi (1), due per lato.

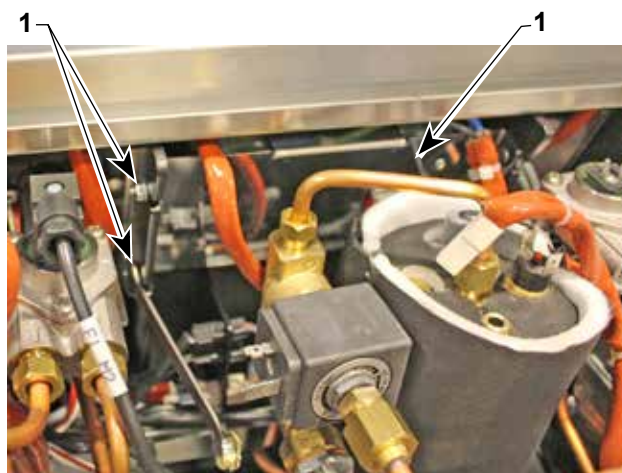

- Scollegare il connettore (2).

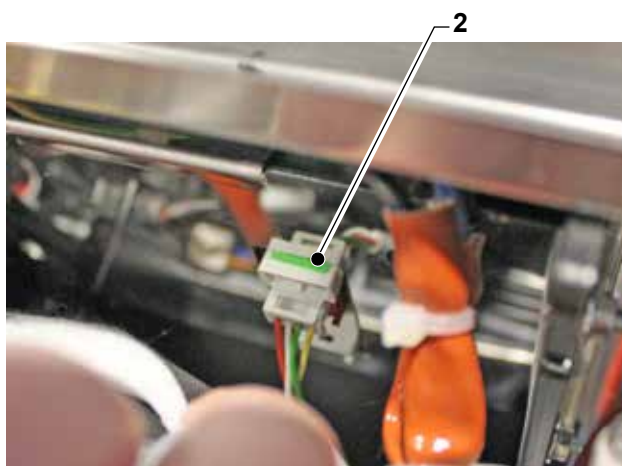

IT

- Estrarre la scheda display (3).

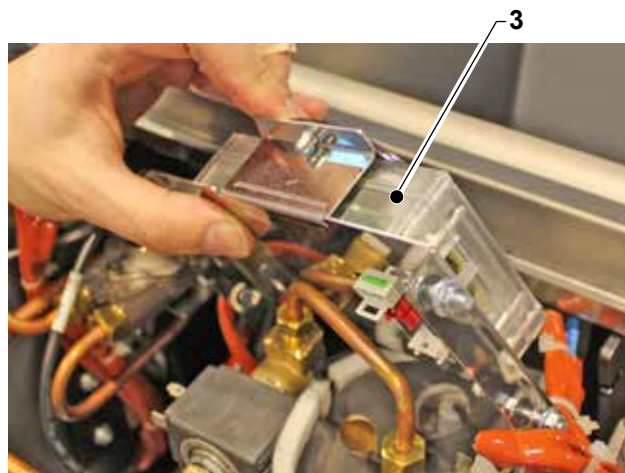

- Svitare la vite (4) e rimuovere la cornice (5).
- Svitare le due viti (6) e rimuovere la scheda display (7) dalla staffa (8).

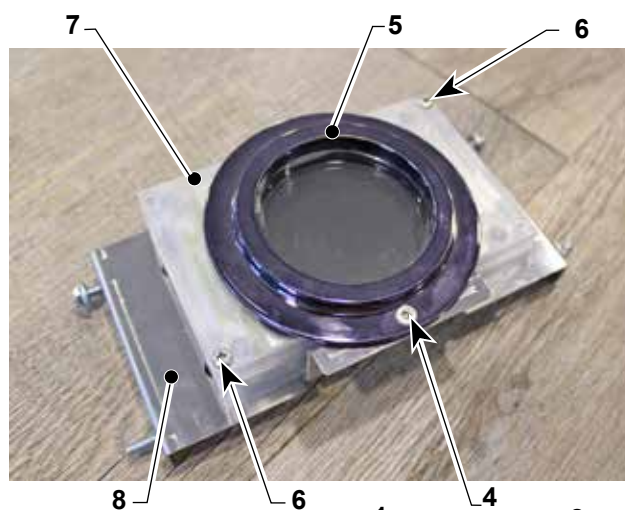

7.24 Sostituzione display gruppo

- Rimuovere i carter gruppo caffè come indicato nel relativo paragrafo.
- Scollegare i due connettori (1) e (2) e rimuovere la spugna (3).

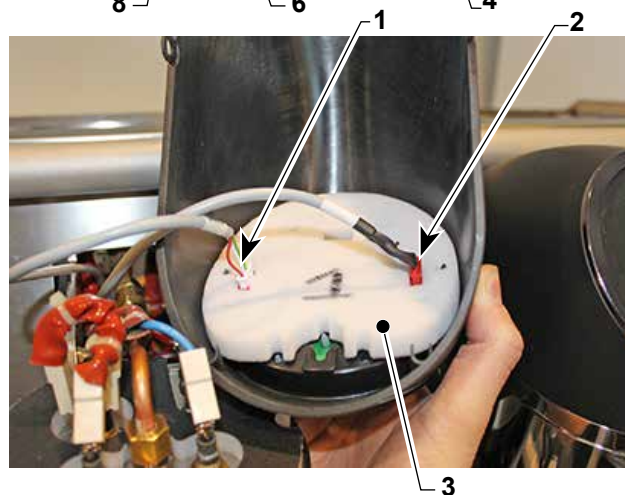

- Svitare le tre viti (1) frontali.

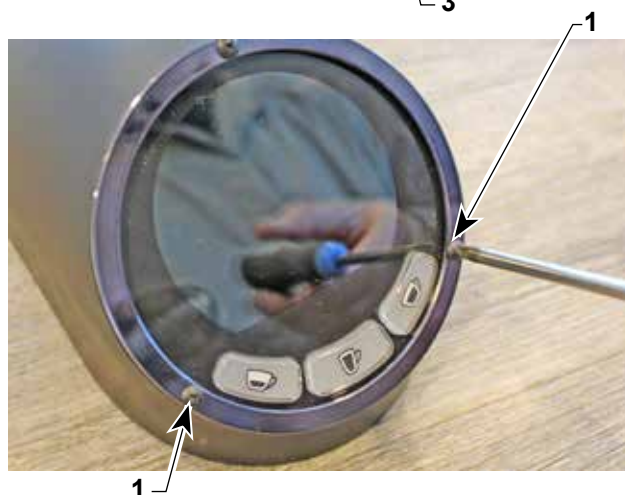

- Rimuovere la cornice esterna (2).



- Rimuovere la cornice interna (3).



- Svitare le due viti (4) e rimuovere il display (5).

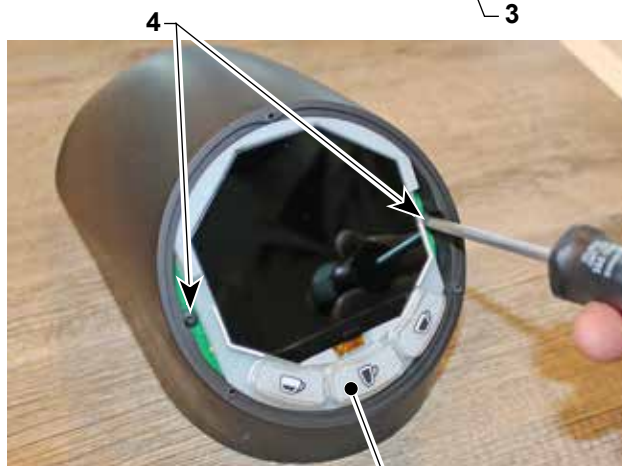

- Dopo aver sostituito il display è necessario impostare il dip-switch (6) in funzione se il display viene montato sul gruppo "1", "2" o "3", per la regolazione del dip-switch fare riferimento alla figura.

1° Gruppo

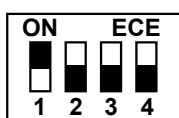

2° Gruppo



3° Gruppo

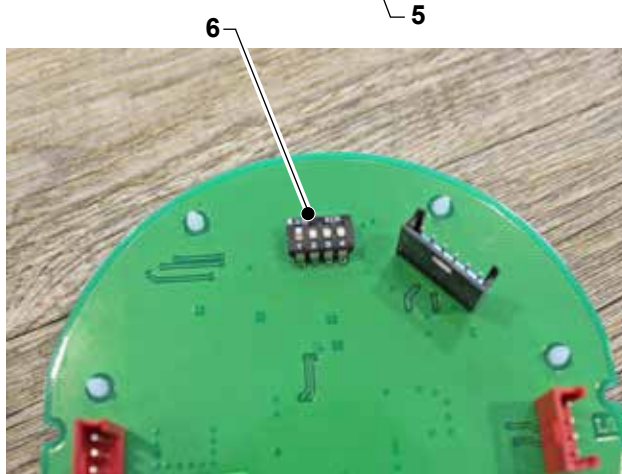

IT

7.25 Rimozione caldaia servizi

- Rimuovere lo scaldabagno e il pannello laterale destro come indicato nei relativi paragrafi.
- Scollegare i cavi (1) di collegamento elettrico resistenza (2).
- Svitare il dado (3) e rimuovere il filo di massa (4).
- Svitare il dado (5) e staccare il tubo (6) di collegamento rubinetto vapore destro.

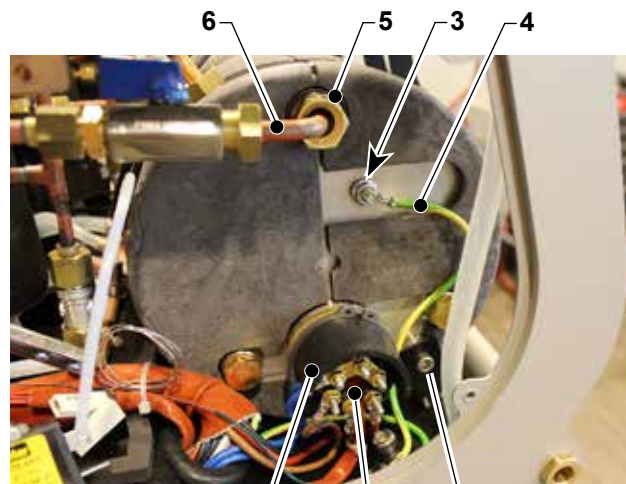

- Svitare e rimuovere la sonda temperatura (7).
- Scollegare il connettore (8) sonda livello massimo.
- Scollegare il connettore (9) sonda livello minimo.
- Svitare il dado (10) e scollegare il tubo (11) sfiato aria.

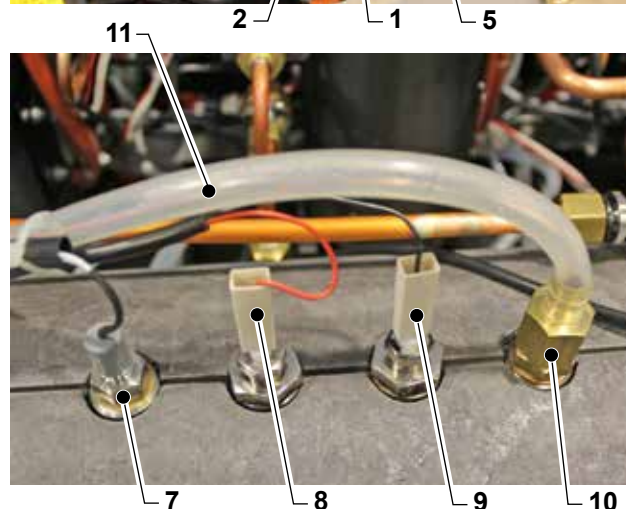

- Svitare il dado (12) e rimuovere il tubo (13) trasduttore.

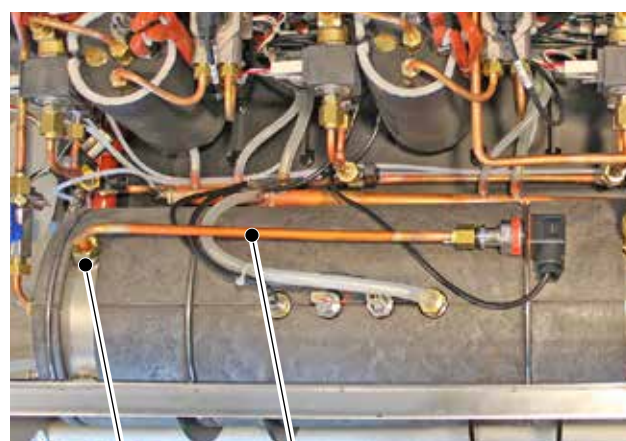

- Svitare il dado (14) e staccare il tubo (15) di collegamento rubinetto vapore sinistro.
- Svitare i dadi (16) e staccare il tubo (17) di collegamento elettrovalvola acqua miscelata.

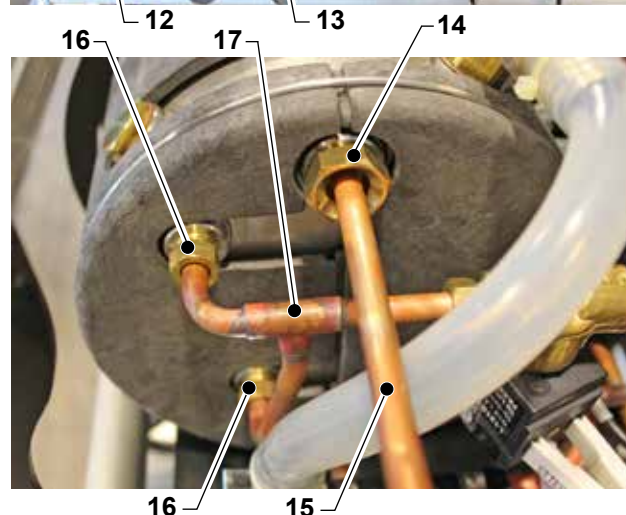

IT

- Svitare il dado (18) del tubo di scarico caldaia.



- Tagliare la fascetta (19) e rimuovere il tubo (20) scarico valvola di sicurezza.
- Sfilare la caldaia dall'alto.

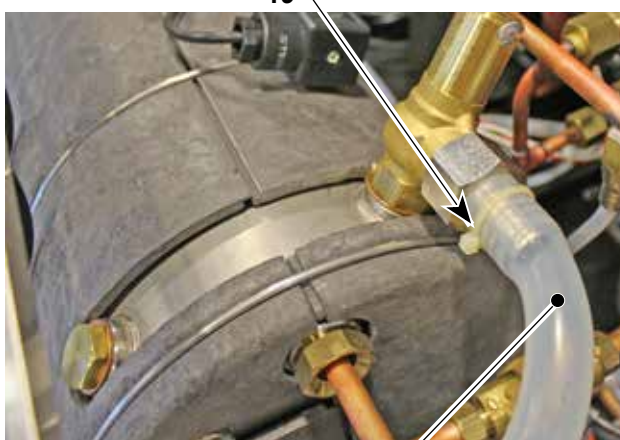

7.26 Sostituzione rubinetto vapore

- Rimuovere lo scaldatazze come indicato nel relativo paragrafo.
- Chiudere il rubinetto (1) relativo al rubinetto vapore da sostituire.

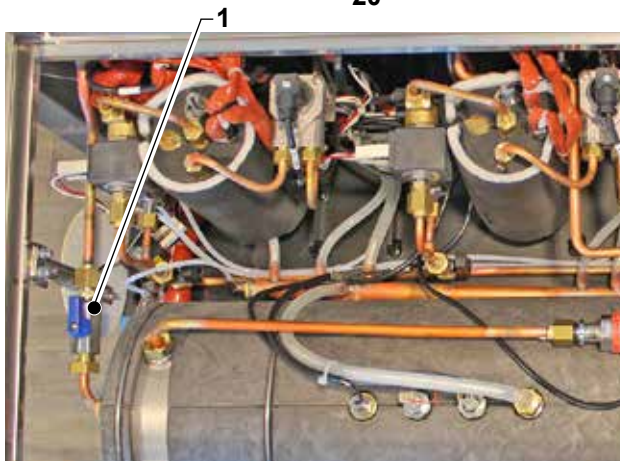

IT

- Svitare il dado (2) e staccare il tubo (3).
- Svitare il dado (4) di fissaggio rubinetto al corpo macchina.

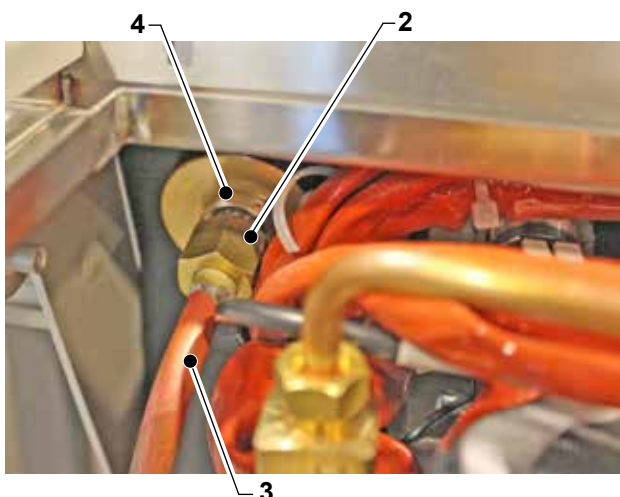

- Rimuovere il rubinetto (5) dalla parte anteriore.

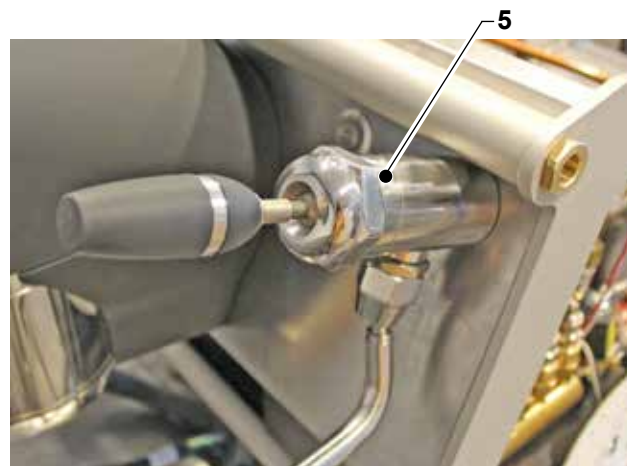

7.27 Sostituzione termostato di sicurezza.

- Rimuovere il pannello destro come indicato nel relativo paragrafo.
- Svitare le due viti (1), staccare il termostato (2) dalla squadretta di sostegno e scollegare i faston.

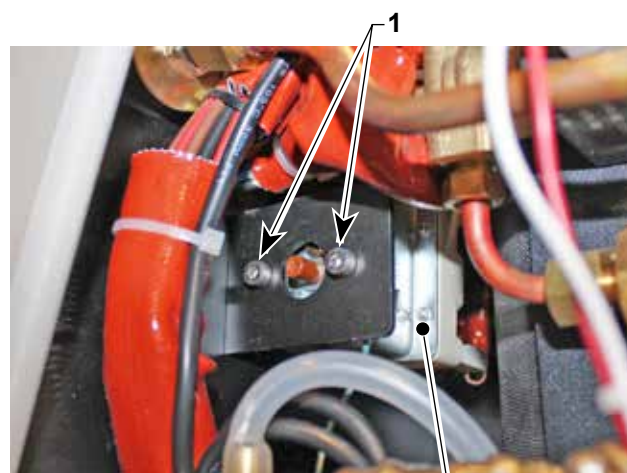

- Tagliare la fascetta (3) e (4) e sfilare il bulbo (5).
- Al rimontaggio fare attenzione a ricollegare correttamente i faston e il corretto posizionamento delle fascette .

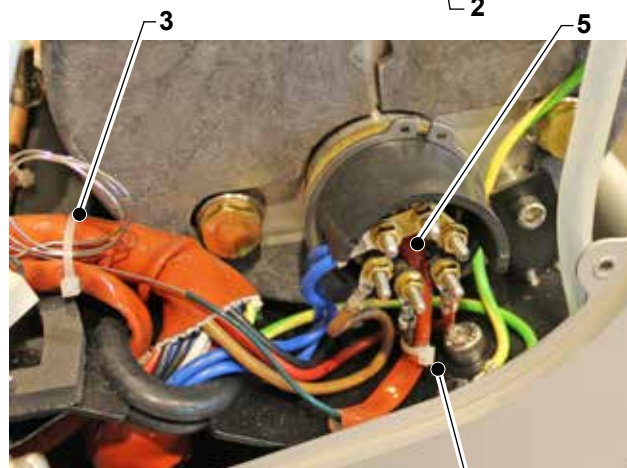

7.28 Sostituzione pulsante rubinetto erogazione acqua.

- Svitare le due viti (1) e rimuovere la ghiera (2).



IT

- Allentare le viti (3) e staccare il fili (4).
- Al rimontaggio ricollegare correttamente i fili (4).

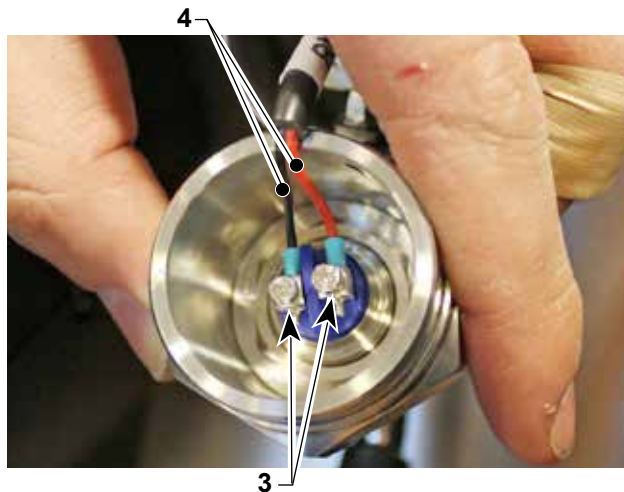

7.29 Sostituzione barra led.

- Rimuovere il pannello sinistro completo di spalla e il pannello anteriore inferiore come indicato nei relativi paragrafi.
- Svitare le tre viti (1).

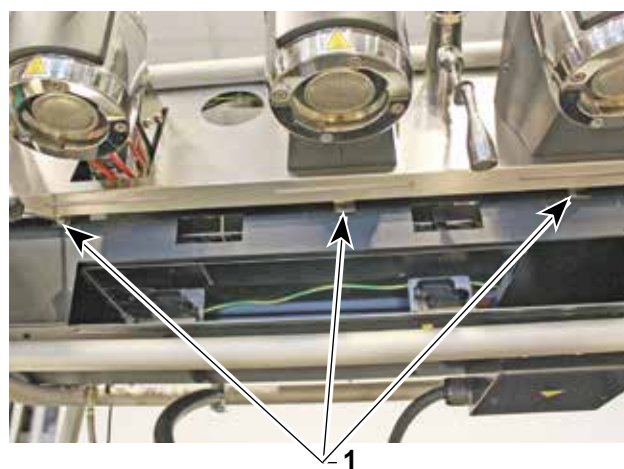

- Scollegare il connettore (2).

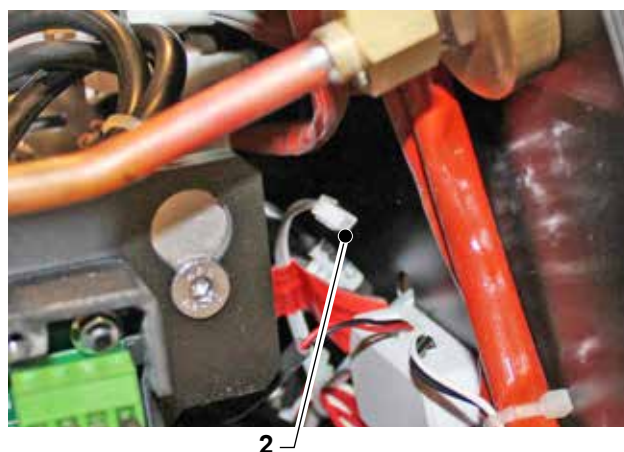

- Sfilare lateralmente la barra led (3).

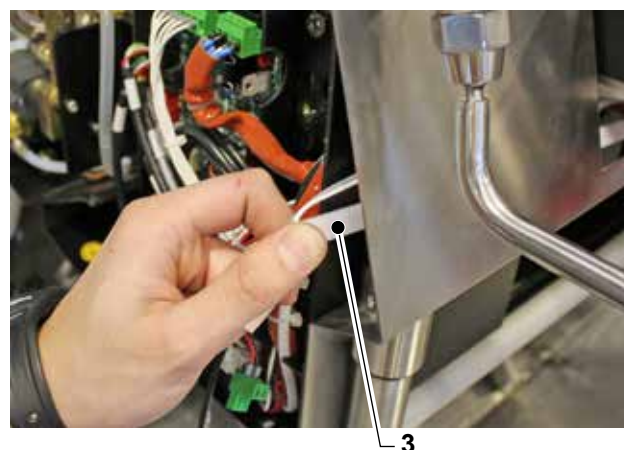

IT

7.30 Sostituzione interruttore generale.



Accertarsi che l'interruttore generale posto a monte della macchina sia in posizione "OFF" quindi posizionare un cartello sull'interruttore generale indicando "Manutenzione in corso" in modo che nessuno inserisca tensione alla macchina durante questa operazione.

- Rimuovere lo scaldatasse come indicato nel relativo paragrafo.
- Tagliare la fascetta (1)
- Scollegare tutti i connettori (2).
- Svitare la ghiera (3).

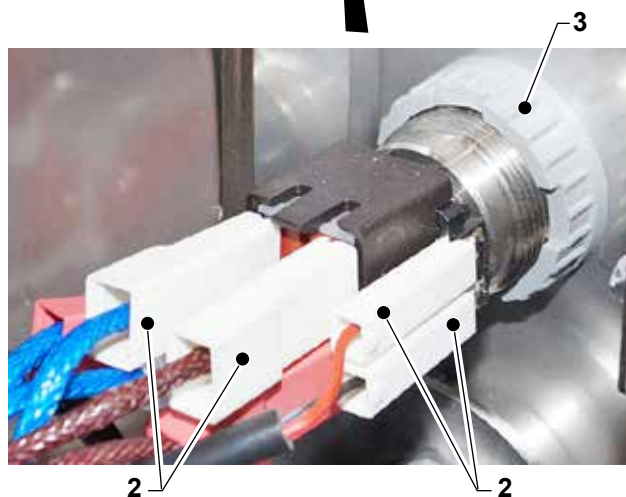
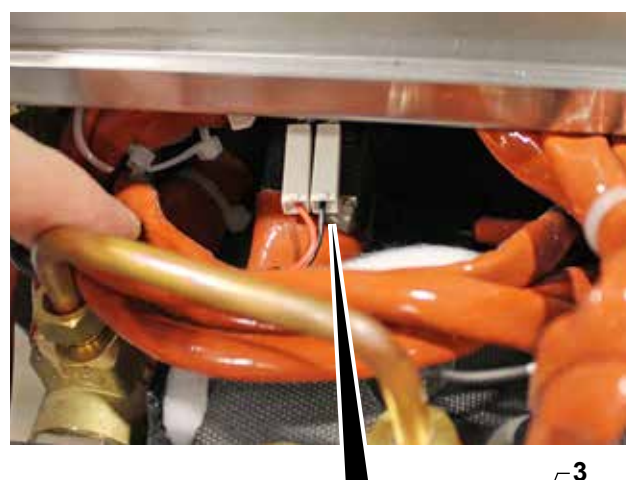
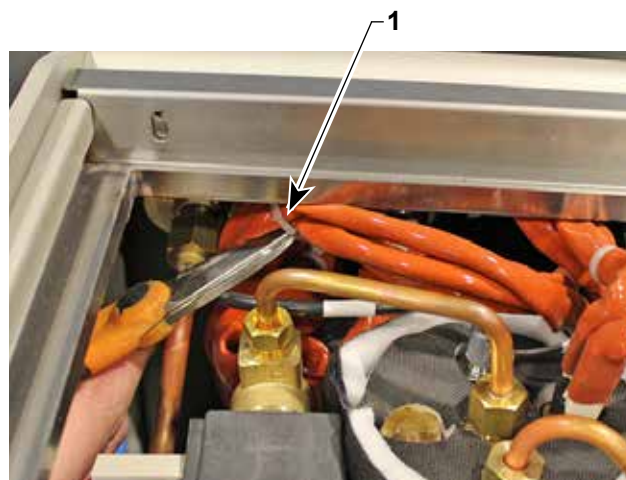

- Rimuovere l'interruttore (4).
- Rimontare il tutto procedendo in senso inverso allo smontaggio riferendosi allo schema elettrico allegato per i collegamenti elettrici.



IT

7.31 Smontaggio doccetta e guarnizioni

- Fare leva con un cacciavite e rimuovere la doccetta (1) e con la relativa guarnizione (2).

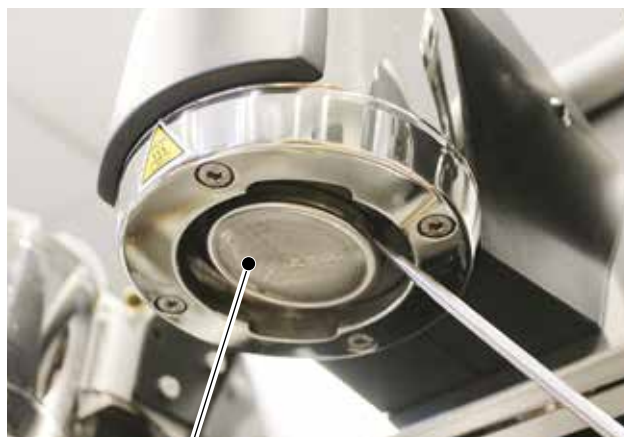

- Inserire la nuova guarnizione (2) sulla doccetta (1).
- Gli angoli smussati "A" della guarnizione devono essere rivolti verso la parte superiore.

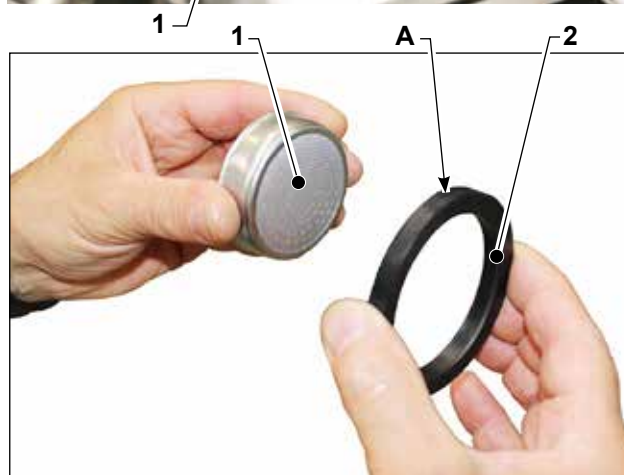

- Togliere il filtro dal portafiltro (3) e montare la doccetta con la guarnizione sul portafiltro (3).



- Bagnare la doccetta con acqua e montare il portafiltro (3) in macchina facendo una buona pressione.
- Bloccare il portafiltro (3).



IT

8. PROGRAMMAZIONE DEL TECNICO

- Per entrare in programmazione si deve portare in OFF elettronico la macchina premendo e mantenendo premuto il tasto centrale (1), quindi con tasto (1) premuto premere il tasto (2), sul display appare "oFF", il tasto (2) lampeggia.



- Premere e mantenere premuto il tasto (1) fino a che sul display (3) appare la scritta "PASSWORD"; premere il tasto (1) per cinque volte per entrare nella fase di programmazione tecnico; la password di default è "11111".

La programmazione del tecnico è strutturata con videate in cascata delle varie sequenze di programmazione e quindi, per accedere alla sequenza di programmazione desiderata, è necessario scorrere all'interno delle sequenze, confermando i dati impostati, fino a posizionarsi sulla sequenza desiderata da modificare.



Le sequenze di programmazione sono le seguenti:

- Lingua
- Nome
- Tel. Assistenza
- Numero gruppi
- Funzione crono
- Carico + Caffè
- Watt
- Trasduttore pressione vapore
- Offset pressione pompa
- Programmazione dosi
- Quattro dosi
- Offset contatore volumetrico 1
- Offset contatore volumetrico 2
- Offset contatore volumetrico 3
- Sensibilità
- Cicli di manutenzione
- Temperatura
- Temperatura caldaia
- Offset temperatura gruppo 1
- Offset temperatura gruppo 2
- Offset temperatura gruppo 3
- Tempo inattività
- Offset temperatura riposo
- Timeout riempimento
- Filtro acqua
- Numero crediti
- Ciclo di raffreddamento
- Cambio password

IT

8.1 Lingua

In questa sezione è possibile impostare la lingua di visualizzazione dei messaggi sul display:

- premere il tasto “☰” o il tasto “☷” per cambiare la lingua; premere il tasto “☶” per confermare la scelta e passare alla prossima sezione.

Le lingue disponibili sono:

Italiano, Inglese, Francese, Tedesco, Spagnolo.



8.2 Nome

In questa sezione è indicato il nome della macchina

- Premere il tasto “☶” per passare alla prossima sezione.



8.3 Tel. assistenza

In questa sezione è possibile impostare il numero di telefono del centro di assistenza, il numero che lampeggia è quello modificabile;

- per impostare il numero premere il tasto “☰” per confermare il numero e passare al numero successivo premere il tasto “☾”;
- premere il tasto “☶” per confermare il numero di telefono impostato e passare alla prossima sezione.



8.4 Numero gruppi

In questa sezione è impostato il numero di gruppi che deve essere sempre “3”.

- Premere il tasto “☶” per confermare la scelta e passare alla prossima sezione.



8.5 Funzione crono

La funzione crono permette la visualizzazione dei secondi di erogazione caffè sul display del gruppo.

- Per abilitare o disabilitare la funzione premere il tasto “☕”
- Premere il tasto “☕” per confermare la scelta e passare alla prossima sezione.



8.6 Carico + caffè

In questa sezione è possibile abilitare o disabilitare il carico acqua durante l'erogazione del caffè;

- se vogliamo mantenere costante la pressione impostare "DISABILITATO" altrimenti impostare "ABILITATO";
- Per abilitare o disabilitare la funzione premere il tasto “☕”
- Premere il tasto “☕” per confermare la scelta e passare alla prossima sezione.



8.7 Watt

In questa funzione è possibile impostare la potenza della macchina da un minimo di 3500 watt a un massimo "Full" di 8750 watt; di default è 6500 watt.

- Per modificare i watt premere il tasto “☕” o il tasto “☕”
- Premere il tasto “☕” per confermare la scelta e passare alla prossima sezione.



8.8 Trasduttore pressione vapore

In questa funzione è possibile abilitare o disabilitare il trasduttore di pressione posizionato sopra la caldaia sevizi.

- In questo caso il trasduttore di pressione deve essere ABILITATO.
- Premere il tasto “☕” per passare alla prossima sezione.



IT

8.9 Offset pressione pompa

In questa funzione si visualizza il differenziale tra la pressione impostata e la pressione pompa reale. Il dato impostato è "0,8" e questo dato non va cambiato.

- Premere il tasto "☕" per passare alla prossima sezione.



8.10 Programmazione dosi

In questa funzione è possibile abilitare o disabilitare la programmazione delle dosi tramite tasti. In questo caso lasciare ABILITATO.

- Premere il tasto "☕" per passare alla prossima sezione.



8.11 Quattro dosi

In questa funzione si abilita la multifunzione dei tasti; lasciare la scelta "SI".

- Premendo una volta il tasto "☕" si erogherà un caffè corto.
- Premendo due volte consecutive il tasto "☕" si erogheranno due caffè corti.
- Premendo una volta il tasto "☕" si erogherà un caffè lungo.
- Premendo due volte consecutive il tasto "☕" si erogheranno due caffè lunghi.
- Premere il tasto "☕" per passare alla prossima sezione.



8.12 Offset contatore volumetrico 1-2-3

- Se si sono riscontrate discrepanze tra i millilitri impostati e i millilitri erogati è possibile correggere l'impostazione premendo il tasto "☕" o il tasto "☕".
- Premere il tasto "☕" per confermare la scelta e passare alla prossima sezione.



8.13 Sensibilità

In questa sezione è possibile selezionare il tipo di sensibilità della sonda di livello dell'acqua del boiler:

- Tramite il tasto “☺” o il tasto “☹” è possibile impostare la sensibilità in “Bassa” - “Media” - “Alta” in funzione all'acidità dell'acqua; con acidità dell'acqua alta la sonda va impostata con sensibilità bassa, viceversa va impostata con sensibilità alta.
- Normalmente impostando la sensibilità “MEDIA” si copre il 90% dei casi.
- Premere il tasto “☹” per confermare la scelta e passare alla prossima sezione.



8.14 Cicli manutenzione

In questa sezione è possibile impostare il numero dei cicli di erogazione, raggiunti i quali, è necessario effettuare una manutenzione alla macchina.

- Tramite il tasto “☺” o il tasto “☹” è possibile impostare i cicli.
- Al raggiungimento del numero di cicli impostati sul display appare il numero di telefono dell'assistenza.
- Premere il tasto “☹” per confermare la scelta e passare alla prossima sezione.



8.15 Temperatura

In questa sezione è necessario verificare che si impostato “ABILITATO”.

- Premere il tasto “☹” per passare alla prossima sezione.



8.16 Temperatura (C° / F°)

In questa sezione è possibile impostare la scala di temperatura visualizzabile °C o °F:

- Tramite il tasto “☺” o il tasto “☹” è possibile impostare la scala.
- Premere il tasto “☹” per confermare la scelta e passare alla prossima sezione.



IT

8.17 Temperatura caldaia

In questa sezione è necessario verificare che la temperatura della caldaia servizi sia impostata a 124°C / 255°F

- Premere il tasto “☕” per passare alla prossima sezione.



8.18 Offset temperatura gruppo 1-2-3

Se si sono riscontrate discrepanze tra la temperatura impostata e la temperatura reale è possibile correggerle aumentando e diminuendo la temperatura del gruppo.

- Tramite il tasto “☕” o il tasto “☕” è possibile impostare il valore.
- Premere il tasto “☕” per passare alla prossima sezione.



8.19 Tempo di inattività

Nel caso la macchina sia installata in un chiosco all'aperto, la temperatura ambientale sia bassa e che per alcuni minuti la macchina sia inattiva, il gruppo può perdere 0,5 °C o 1°C.

- E' possibile impostare un tempo di inattività oltre al quale la macchina automaticamente aumenta la temperatura del gruppo pari al valore impostato nella videata successiva “OFS TEMP. RIPOSO”.
- Tramite il tasto “☕” o il tasto “☕” è possibile impostare i valori.
- Premere il tasto “☕” per passare alla prossima sezione.



In questa videata è possibile impostare i gradi di aumento della temperatura del gruppo, per sopperire all'inattività ed al clima freddo.

- Normalmente questa funzione non serve quindi impostare il valore “0” in entrambe le videate per disabilitare la funzione.
- Premere il tasto “☕” per passare alla prossima sezione.



IT

8.20 Timeout riempimento

In questa sezione è possibile impostare il tempo di apertura elettrovalvola riempimento acqua, trascorso il quale, se il riempimento non è avvenuto, la macchina va in blocco.

- Tramite il tasto “☕” o il tasto “☕” è possibile impostare il valore (normalmente si impostano 120 secondi).
- Premere il tasto “☕” per confermare la scelta e passare alla prossima sezione.



8.21 Filtro acqua

In questa sezione si può impostare dopo quanti litri di acqua utilizzata per erogare caffè è necessario sostituire il filtro acqua.

- Tramite il tasto “☕” o il tasto “☕” è possibile impostare i litri.
- Premere il tasto “☕” per confermare il valore e passare alla prossima sezione.



8.22 Numero crediti

In questa sezione si può impostare dopo quanti caffè la macchina si blocca questa funzione si può abilitare o disabilitare;

- Tramite il tasto “☕” o il tasto “☕” è possibile abilitare o disabilitare la funzione o impostare il n° di caffè massimi da erogare;
 - se scelgo “DISABILITATO” premendo il tasto “☕” passo alla sezione successiva;
 - se scelgo di impostare la quantità di caffè oltre la quale la macchina si ferma, tramite il tasto “☕” o il tasto “☕” imposto il valore.
- Premere il tasto “☕” per confermare il valore e passare alla prossima sezione.



8.23 Ciclo di raffreddamento

In questa sezione è possibile abilitare la funzione che permette lo svuotamento della caldaia servizi per rigenerare l'acqua contenuta.

- Tramite il tasto “☕” o il tasto “☕” scegliere “SI” o “NO”.
- Scegliendo “SI” in automatico inizia il ciclo di svuotamento disabilitando le resistenze di riscaldamento, alla fine del ciclo la macchina uscirà automaticamente dal menù tecnico.
- È possibile fermare questa operazione premendo una qualsiasi dei tasti della prima pulsantiera di sinistra.
- Scegliendo “NO” e premendo il tasto “☕” si passa alla sezione successiva.



IT

8.24 Password

In questa sezione è possibile variare la password per accedere alla sezione del tecnico.

- Tramite il tasto “☕” impostare “NO” per lasciare la password attuale o “SI” per cambiarla:
- se si è scelto “NO” premendo il tasto “☕” si conferma la scelta e si esce dal menù del tecnico;
- se si è scelto “SI” premendo il tasto “☕” si conferma la scelta e si passa alla prossima videata dove il numero che lampeggia è quello modificabile.

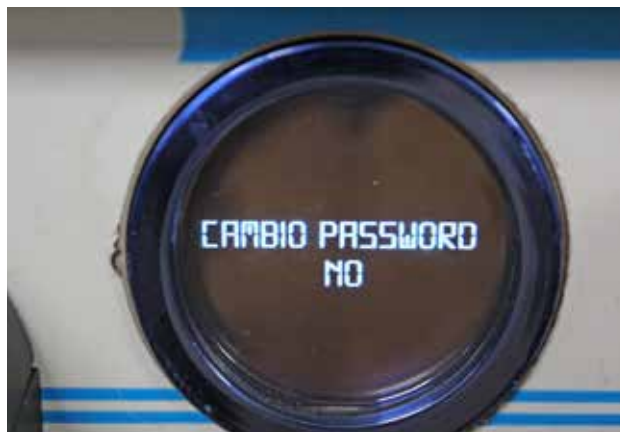

- Per impostare la password utilizzare i pulsanti dei primi due gruppi di sinistra.
- Tasto (A) digito il numero “1”
- Tasto (B) digito il numero “2”
- Tasto (C) digito il numero “3”
- Tasto (D) digito il numero “4”
- Tasto (E) digito il numero “5”
- Tasto (F) digito il numero “6”.
- Impostata la nuova password si esce in automatico dal menù tecnico.

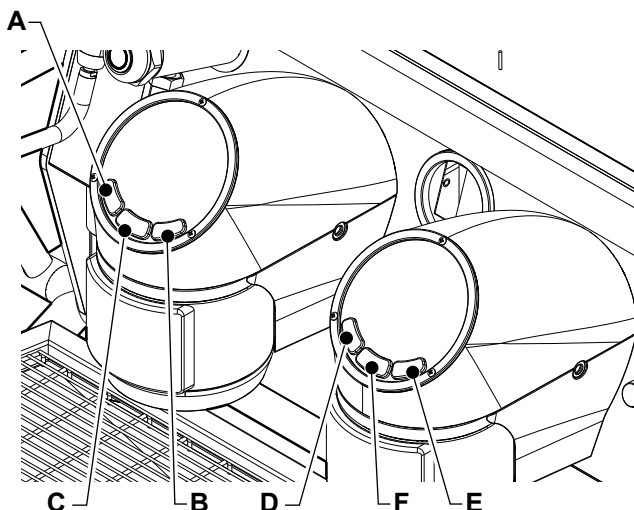

IT

8.25 Funzione conto cassa e lavaggi

A partire dalla revisione del Firmware 1.38 è possibile abilitare il conto cassa.

Collegare il dispositivo contocassa sulla scheda elettronica al connettore CN41 (1), ed installare il dispositivo contocassa sulla lamiera a sinistra della centralina (2).

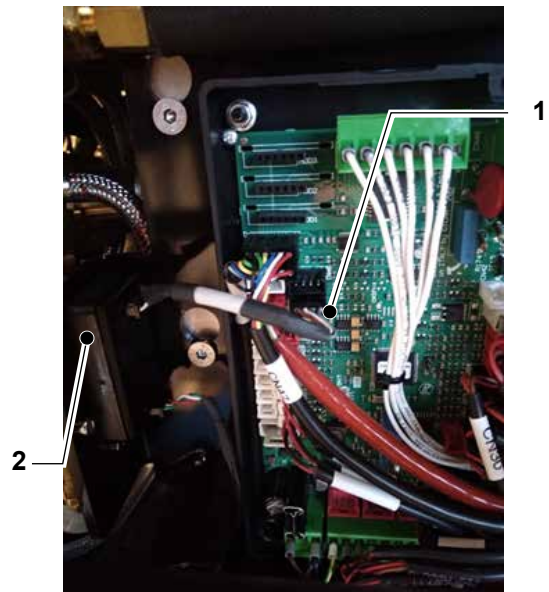

-Portare in OFF la macchina: premere il tasto centrale (C) e premere il tasto (B), sempre tenendo premuto il tasto (C). Sul display appare "oFF" , il tasto (B) lampeggia.



-Premere e mantenere premuto il tasto (C) fino a che sul display appare la scritta "PASSWORD"; premere il tasto (C) per cinque volte per entrare nella fase di programmazione tecnico;



-Effettuare la modalità OFF (F-E) dal gruppo 2, il secondo gruppo della macchina partendo da sinistra.

-Si visualizzerà a display la scritta "CONTO CASSA", utilizzare i tasti (A-B) del gruppo 1 per abilitare/disabilitare il conto cassa, premere il tasto (C) per confermare. Di default il comando è disabilitato.



IT



-Una volta confermato il comando conto cassa si passa automaticamente al comando lavaggio, utilizzare i tasti (A-B) per abilitare/disabilitare i lavaggi dei gruppi, premere il tasto (C) per confermare e tornare alla modalità OFF della macchina. Di default il comando è abilitato.

Il menu lavaggio (default ABILITATO) permette di inibire (se in OFF) l'avvio del lavaggio gruppi onde evitare possa essere anche usato per erogare caffè con conto cassa abilitato.



IT

8.26 Lista allarmi

Di seguito la lista degli allarmi che appaiono sul display del gruppo macchina:

-AL1 sovratemperatura gruppo, sonda difettosa o corto circuito;

-AL2 temperatura minima del gruppo non raggiunta, sonda di temperatura scollegata;

-AL5 sovratemperatura della caldaia di pre riscaldamento, sonda difettosa o corto circuito;

-AL6 temperatura minima della caldaia di pre riscaldamento non raggiunta, sonda di temperatura scollegata;

-ER1 corto circuito elettrovalvola del gruppo;

-ER2 elettrovalvola del gruppo scollegata o difettosa;

-BLINKING il contatore volumetrico non sta funzionando;
BUTTON

Di seguito gli allarmi che appaiono sul display della macchina:

-AL1 sovratemperatura della caldaia vapore, sonda in errore o corto circuito;

-AL2 temperatura minima della caldaia vapore non raggiunta, sonda di temperatura scollegata;

-AL3 sovrappressione caldaia vapore, trasduttore pressione difettoso;

-AL4 pressione minima della caldaia vapore non raggiunta, trasduttore pressione scollegata;

-ER1 corto circuito elettrovalvola acqua calda;

-ER2 elettrovalvola acqua calda scollegata;

-ER3 corto circuito elettrovalvola acqua fredda;

-ER4 elettrovalvola acqua fredda scollegata;

-ER5 corto circuito elettrovalvola riempimento;

-ER6 elettrovalvola riempimento scollegata;

9. HYDRAULIC DIAGRAM

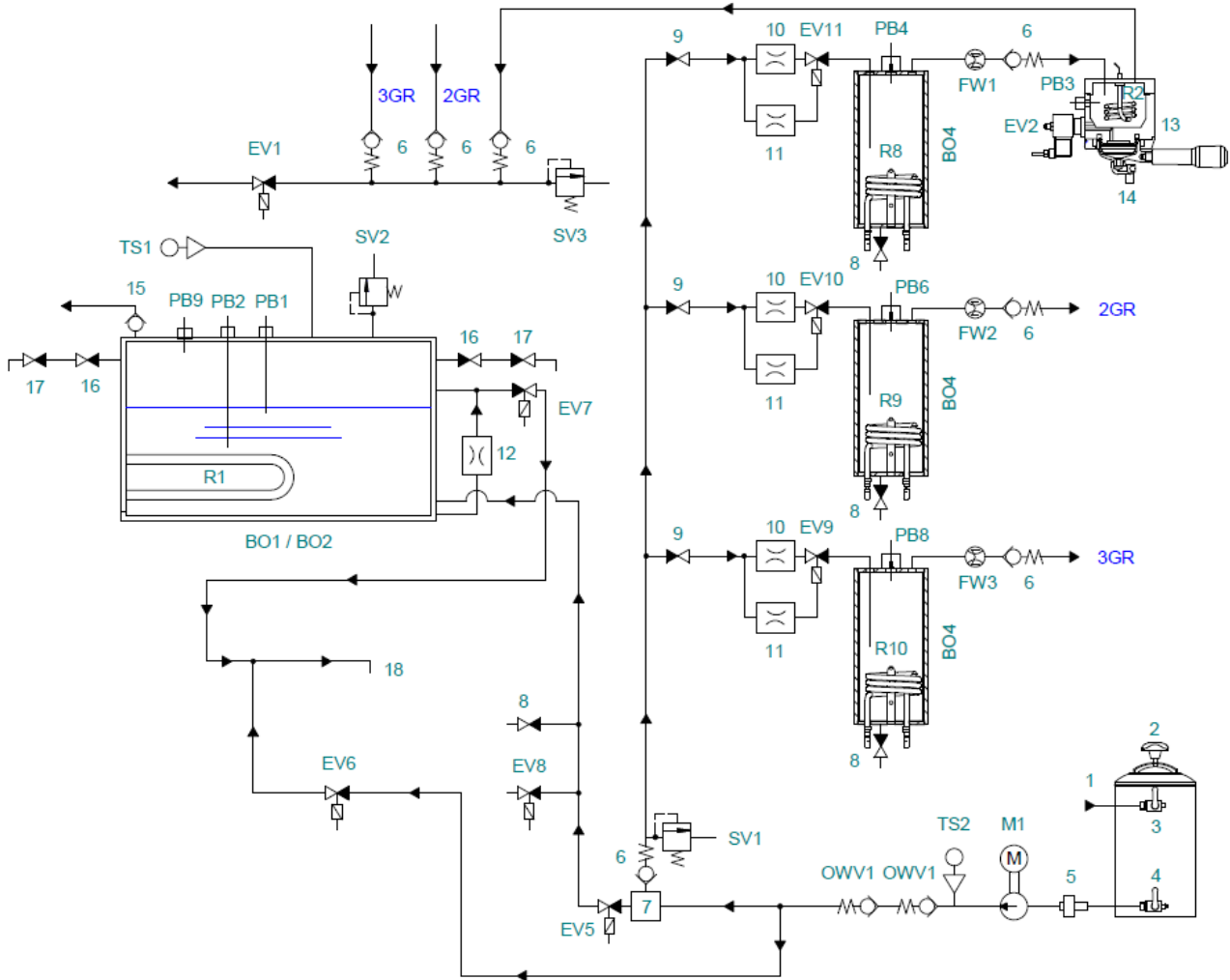

IT

LEGENDA

- 1) Alimentazione rete idrica
- 2) Addolcitore
- 3) Rubinetto entrata acqua
- 4) Rubinetto uscita acqua
- 5) Filtro
- 6) Valvola di non ritorno
- 7) Massello di carico con filtro
- 8) Rubinetto scarico caldaia
- 9) Rubinetto circuito caffè
- 10) Giglieur 0.3mm
- 11) Giglieur 1mm
- 12) Giglieur 2mm
- 13) Gruppo erogatore
- 14) Portafiltro
- 15) Valvola antivuoto
- 16) Rubinetto intercettazione vapore
- 17) Rubinetto prelievo vapore
- 18) Uscita acqua calda
- BO2) Caldaia vapore (2GR)
- BO1) Caldaia vapore (3GR)
- BO4) Caldaietta caffè

- EV1) Elettrovalvola sfiato
- EV2) Elettrovalvola gruppo erogatore
- EV5) Elettrovalvola per riempimento automatico
- EV6) Elettrovalvola acqua fredda miscelata THE
- EV7) Elettrovalvola prelievo vapore
- EV8) Elettrovalvola Cooling cycle
- EV9-10-11) Elettrovalvola preinfusione
- FW1-2-3) Contatore volumetrico
- M1) Motore con pompa 300Litri
- OWV1) Valvola di non ritorno massello di carico
- PB1) Sonda livello di max
- PB2) Sonda livello di minimo
- PB3) Sonda di temperatura gruppo caffè
- PB4-6-8) Sonda di temperatura caldaia caffè
- PB9) Sonda di temperatura caldaia vapore
- R1) Resistenza caldaia vapore
- R2) Resistenza gruppo
- R8-9-10) Resistenza caldaia caffè
- SV1) Valvola espansione 12Bar
- SV2) Valvola di sicurezza
- SV3) Valvola espansione regolabile 12Bar
- TS1) Trasduttore pressione caldaia
- TS2) Trasduttore pressione pompa

10. WIRING DIAGRAM

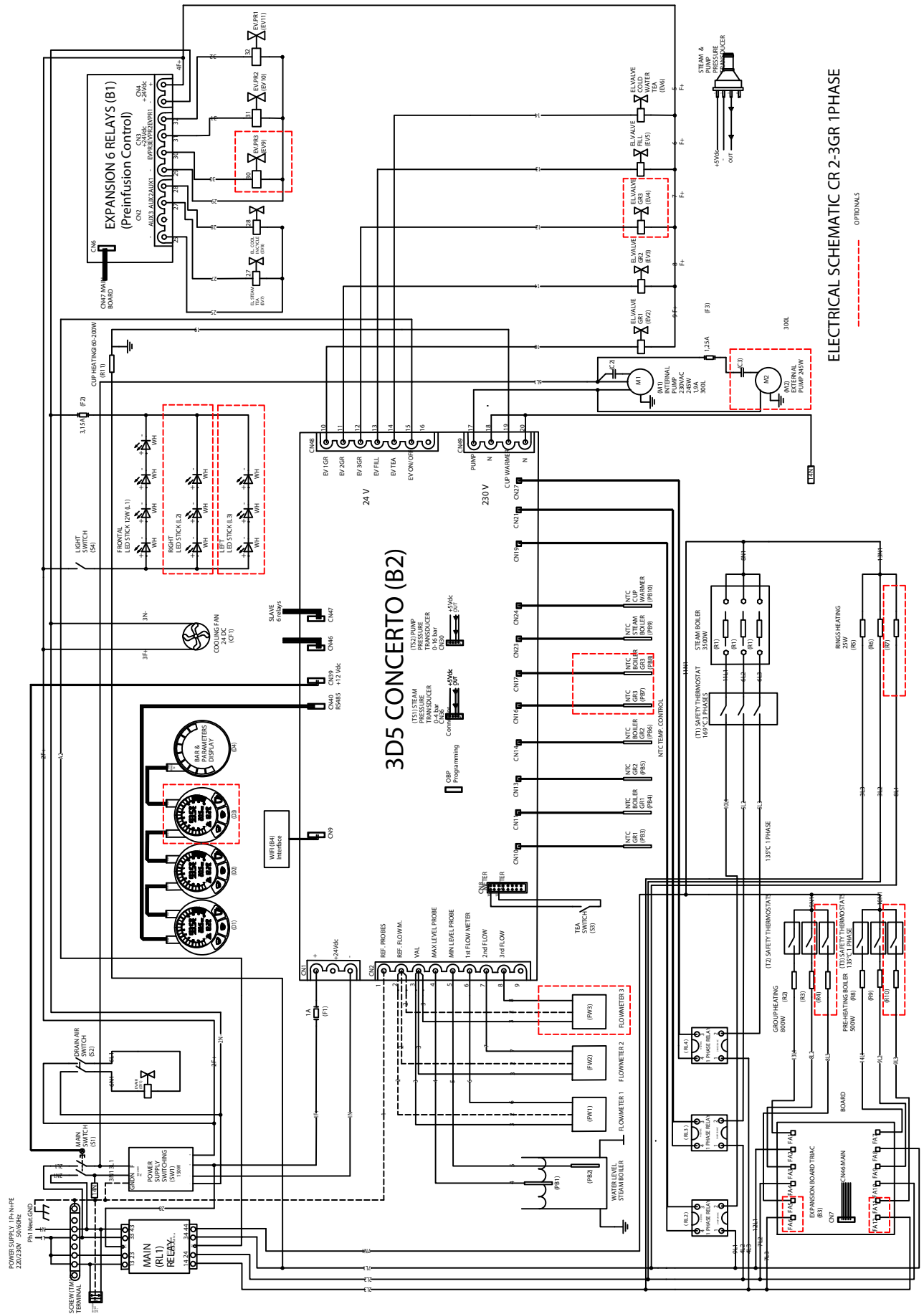

ELECTRICAL SCHEMATIC CR 2-3GR 1PHASE

OPTIONALS



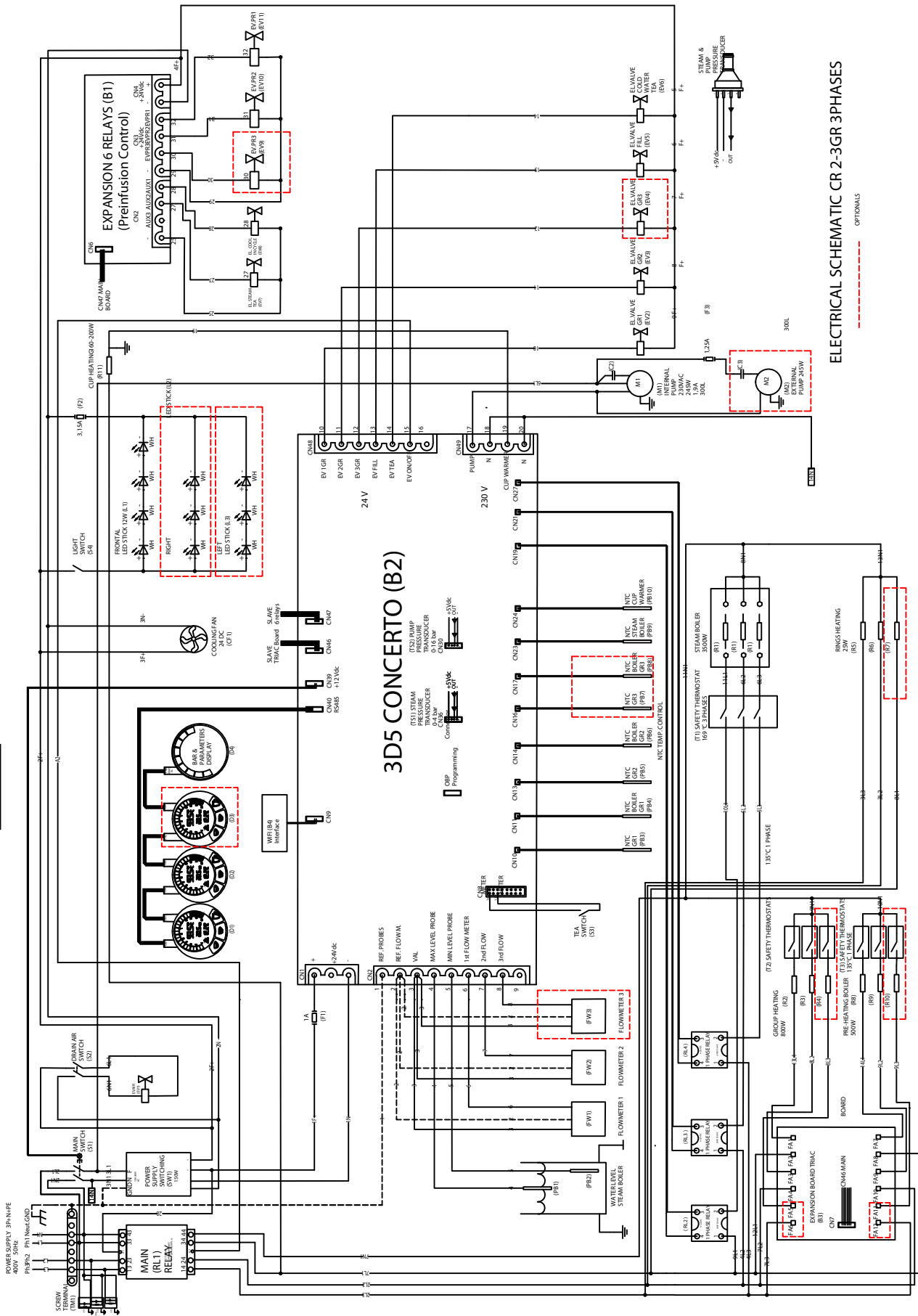

ELECTRICAL SCHEMATIC CR 2-3GR 3PHASES

OPTIONALS

INDEX

1. Introduction..... 66
 1.1 General safety warnings..... 66

2. Removing the tray 67

3. Removing the cup heating plate 69

4. Removing the panels 70
 4.1 Removing the profile side..... 70
 4.2 Removing the rear panel..... 71
 4.3 Removing the coffee unit guard 72
 4.4 Removing the lower front panel..... 73

5. Layout of main components..... 74
 5.1 Top view 74
 5.2 Rear view 75
 5.3 LH side view 76
 5.4 RH side view 77
 5.5 Removing the electrical panel 78
 5.6 Layout of the electrical panel..... 78

6. Adjustments - Resets 79
 6.1 Adjusting mixed water 79
 6.2 Bleeding the air from the circuit..... 79
 6.3 Resetting the service boiler safety thermostat 79
 6.4 Resetting the small boiler safety thermostat 80
 6.5 Resetting the unit safety thermostat..... 80

7. Removals - Replacements 81
 7.1 Replacing the cup heating plate heating element 81
 7.2 Replacing the cup heating plate probe..... 81
 7.3 Replacing the small boiler heating element..... 82
 7.4 Replacing the boiler thermostat..... 84
 7.5 Replacing the unit small boiler 84
 7.6 Replacing the coffee boiler heating element 86
 7.7 Replacing the pump 87
 7.8 Replacing the pump motor 88
 7.9 Replacing the LED plate..... 89
 7.10 Replacing the boiler filling solenoid valve..... 89
 7.11 Replacing the mixed water solenoid valve 90
 7.12 Replacing the hot water solenoid valve..... 91
 7.13 Replacing the cooling cycle solenoid valve 92
 7.14 Replacing the purge solenoid valve 92
 7.15 Replacing the pre-infusion solenoid valve..... 94
 7.16 Replacing the unit solenoid valve..... 94
 7.17 Replacing the displacement counter 95
 7.18 Replacing the pump pressure transducer 96
 7.19 Replacing the service boiler pressure transducer 96
 7.20 Replacing the pre-infusion expansion board 97
 7.21 Replacing the electronic board..... 97
 7.22 Replacing the electrical panel components..... 98
 7.23 Replacing the display board 99
 7.24 Replacing the unit display 100
 7.25 Removing the service boiler 102
 7.26 Replacing the steam tap..... 103
 7.27 Replacing the safety thermostat..... 104
 7.28 Replacing the water dispensing tap button 104
 7.29 Replacing the LED bar 105
 7.30 Replacing the main switch..... 106
 7.31 Removing the head and gaskets..... 107

EN

8. Programming by the technician.....	108
8.1 Language	109
8.2 Name.....	109
8.3 Service tel.....	109
8.4 Number of units	109
8.5 Chrono function	110
8.6 Intake + coffee.....	110
8.7 Watt	110
8.8 Steam pressure transducer	110
8.9 Pump pressure offset	111
8.10 Programming doses	111
8.11 Four doses.....	111
8.12 Displacement counter offset 1-2-3	111
8.13 Sensitivity	112
8.14 Maintenance cycles.....	112
8.15 Temperature	112
8.16 Temperature (C° / F°)	112
8.17 Boiler temperature	113
8.18 Unit temperature offset.....	113
8.19 Inactivity time.....	113
8.20 Filling timeout	114
8.21 Water filter	114
8.22 Number of credits	114
8.23 Cooling cycle	114
8.24 Password.....	115
8.25 Cash register function and cleanin	116
8.26 Alarm list.....	118
9. Hydraulic diagram	119
10. Wiring diagram	120

1. INTRODUCTION

- This manual was written only to be used by authorised technicians of the manufacturer.

1.1 General safety warnings

- When operating on the machine, make sure that the main switch and the machine switch are in **OFF** position and that the water supply tap is closed.
- When some operations/adjustments need to be carried out with the power on, **operate with extreme care.**
- When operating on the machine, check that the water contained in the machine is cold.
- When some operations/adjustments need to be carried out with the machine at operating temperature, **operate with extreme care** and use suitable personal protective equipment.
- Suitable personal protective equipment must be worn in any case as required by current safety regulations in the country of use.
- Current specific regulations in the country of use must be followed at all times.
- See the attached wiring diagram for all operations on the electrical system.
- See the attached water diagram for all operations on the water system.

2. REMOVING THE TRAY

- Remove the grille (1).



- Lift and remove the tray (2).



- Undo the four Allen screws (3).

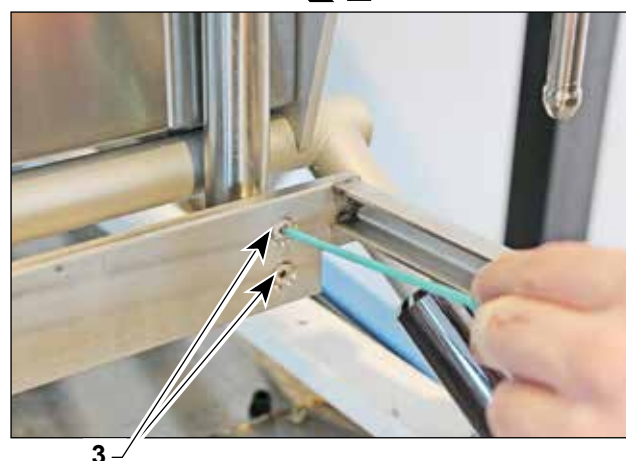
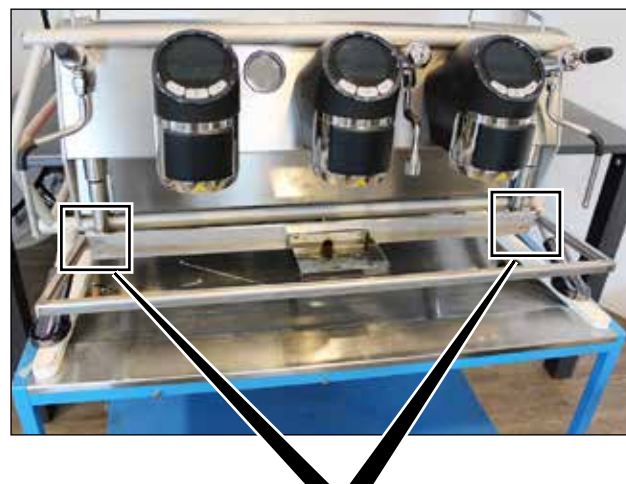

EN

- Loosen the screw (4) and remove the tray support (5).

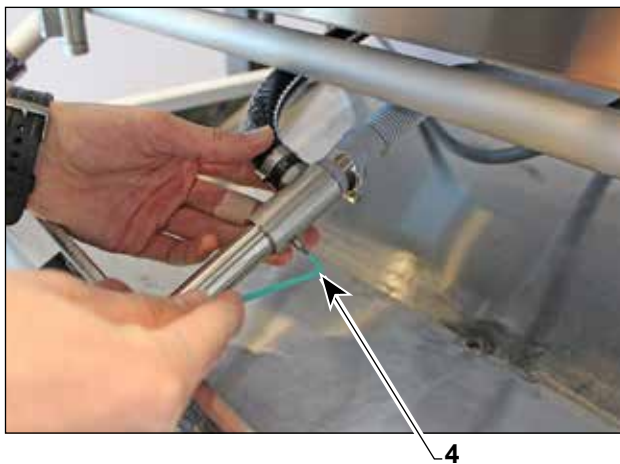

When reassembling the tray (5) check the conditions of the OR gaskets (6) and grease them.



3. REMOVING THE CUP HEATING PLATE

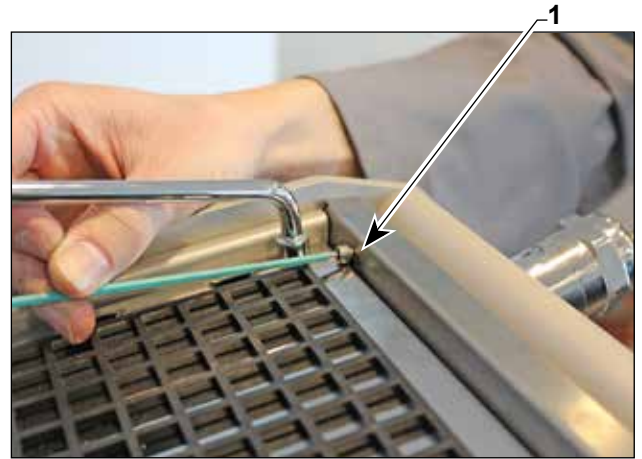

- Unscrew screw (1) on both sides.

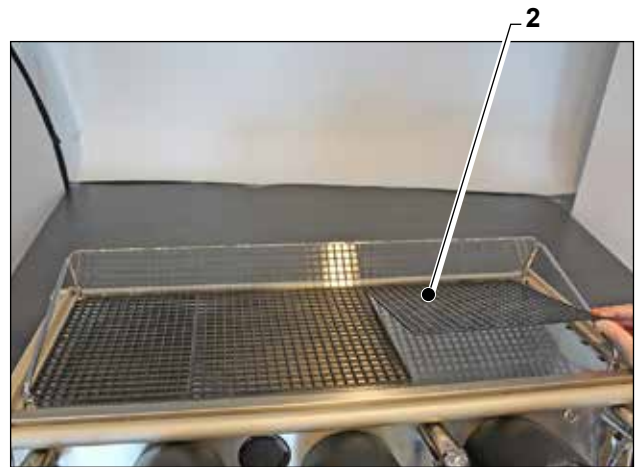

- Remove the grilles (2).

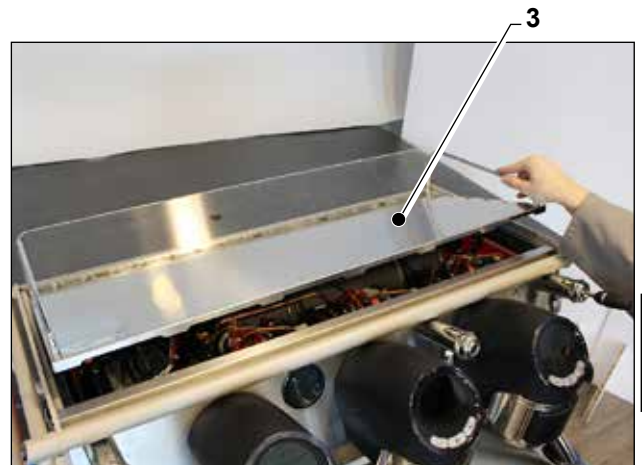

- Lift the cup heating plate (3).
- Disconnect the connector (4) of the probe.
- Disconnect the heating element connector (5).
- Remove the cup heating plate (3).

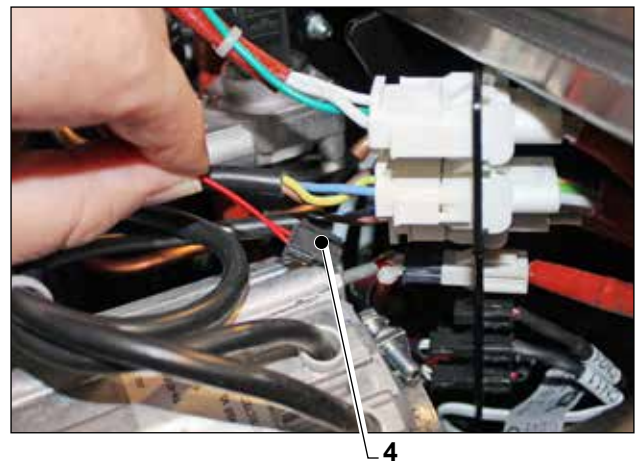
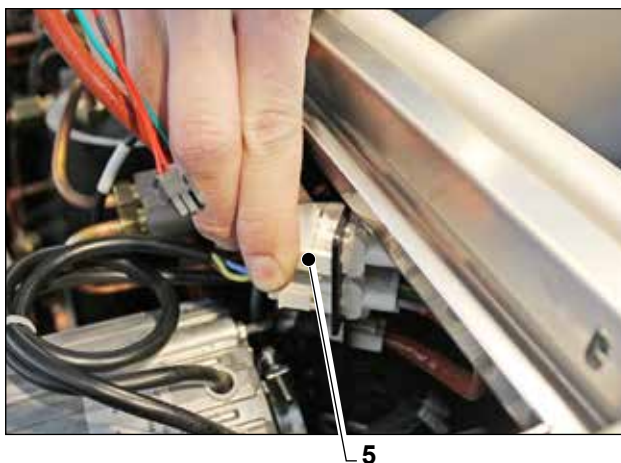

EN

4. REMOVING THE PANELS

 Remove the side panels and the cup heating plate to access all the internal machine components.

4.1 Removing the profile side

- Unscrew the screws (1).

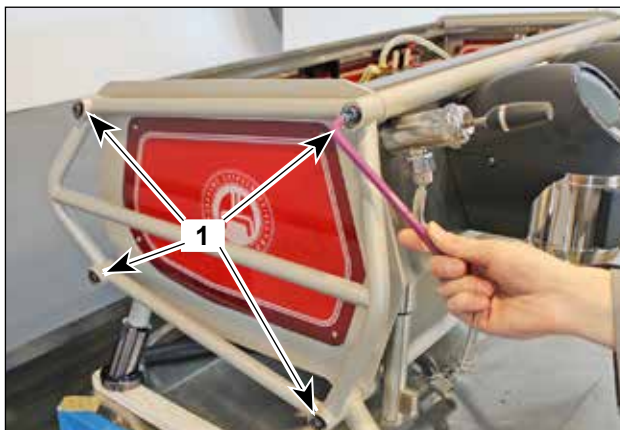

- Remove the profile side (2).

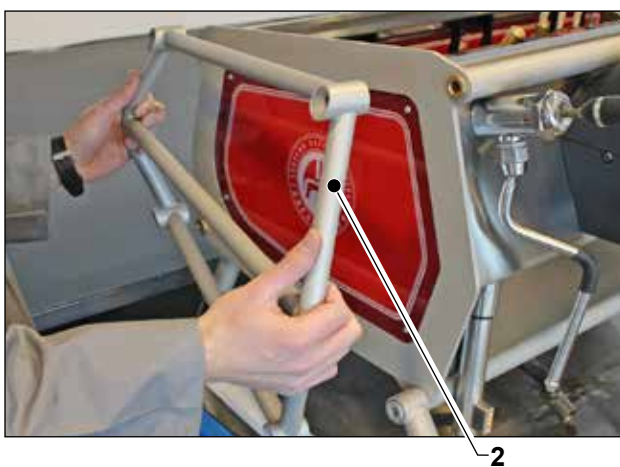

- Unscrew the screws (3) fastening the panel (4).

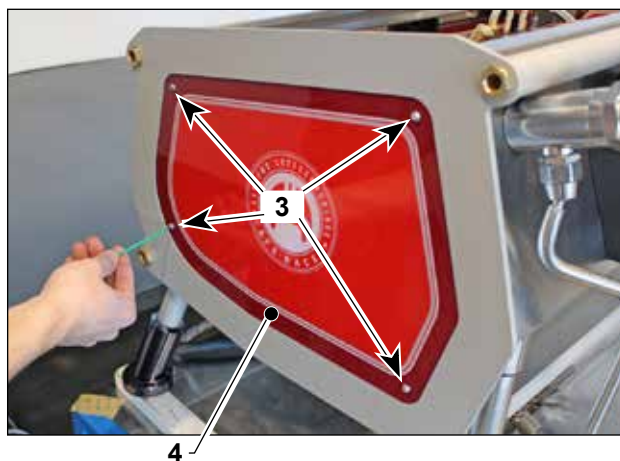

- Remove panel (4).



EN

4.2 Removing the rear panel

- Unscrew the two side screws (1).

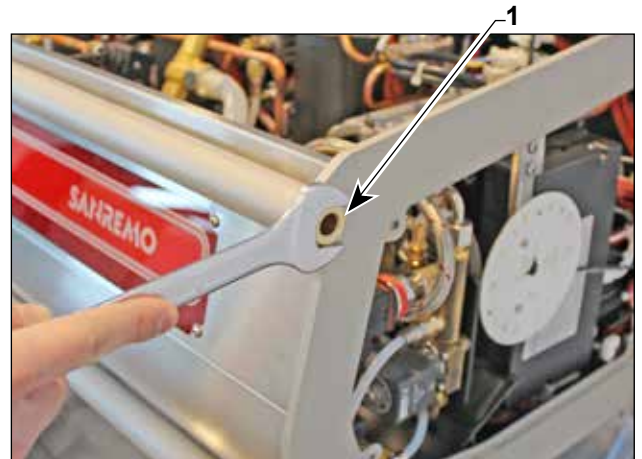

- Remove the pipe (2) connecting the two shoulders.

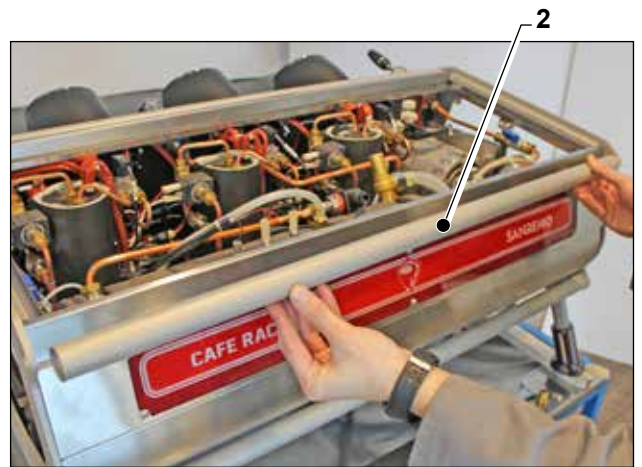

- Unscrew the three screws (3).
- Loosen the three screws (4).

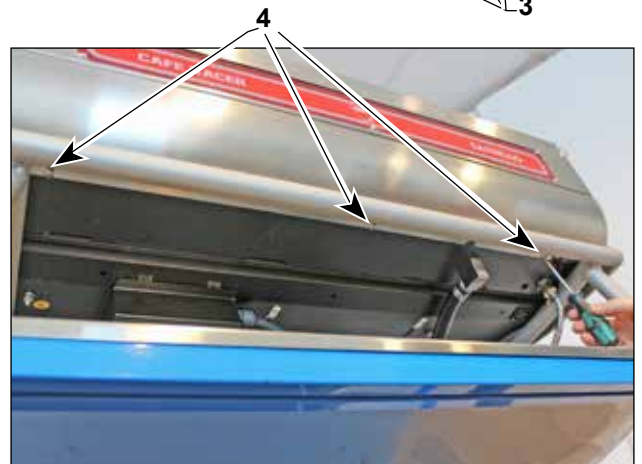
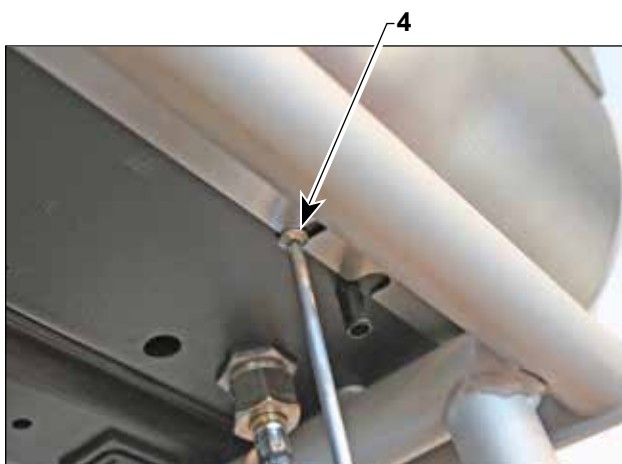
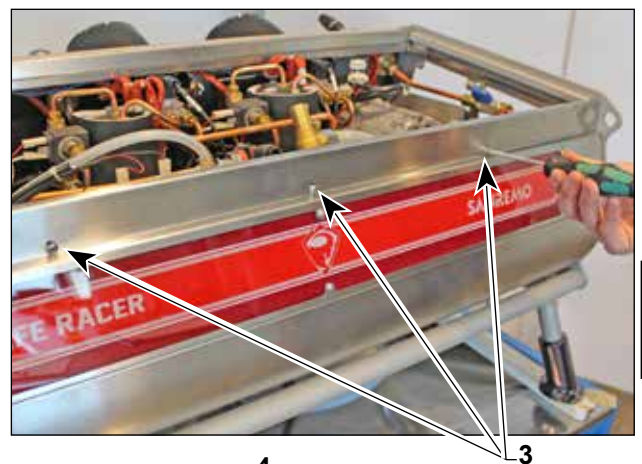

EN

- Remove the rear panel (5).

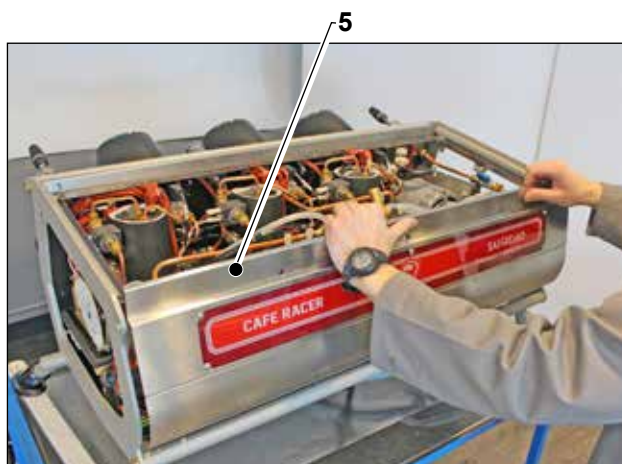

4.3 Removing the coffee unit guard

- Unscrew the screws (1) on both sides.

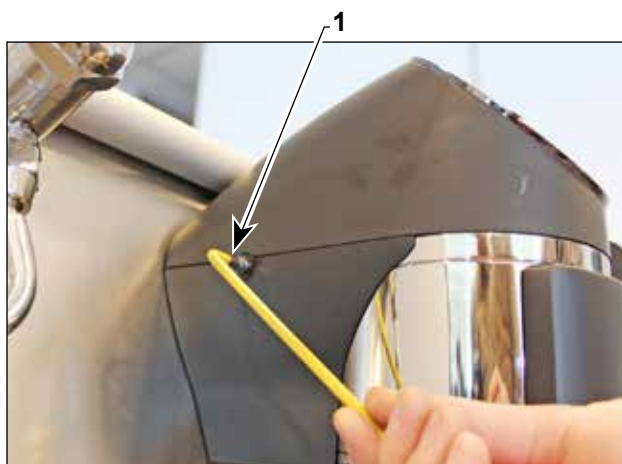

- Widen the two guards (2) and remove them.



- Pull out the guard (3) with the display toward the front.

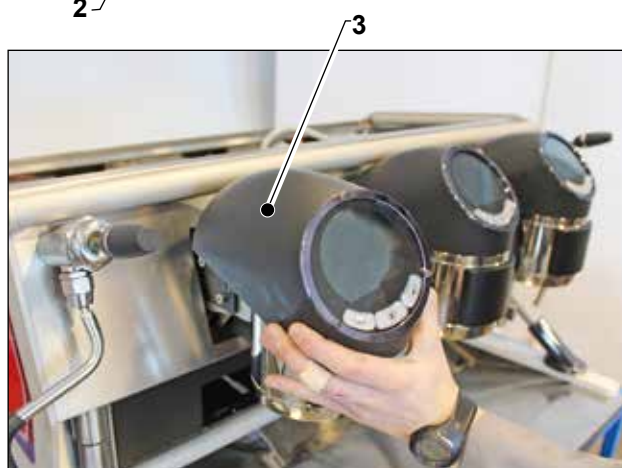

EN

- Disconnect the connectors (4) and (5).

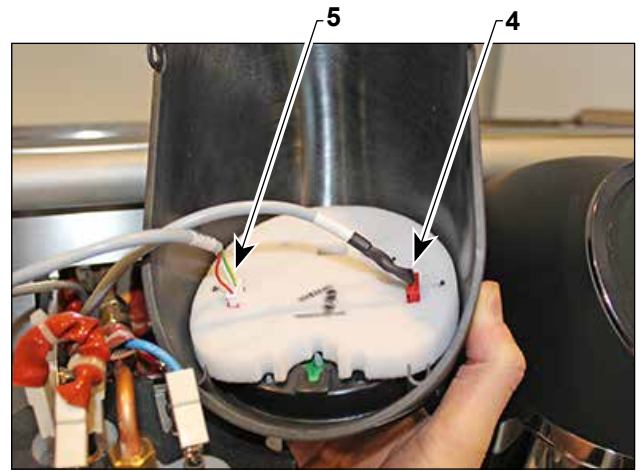

4.4 Removing the lower front panel

- Loosen the two Phillips screws (1).

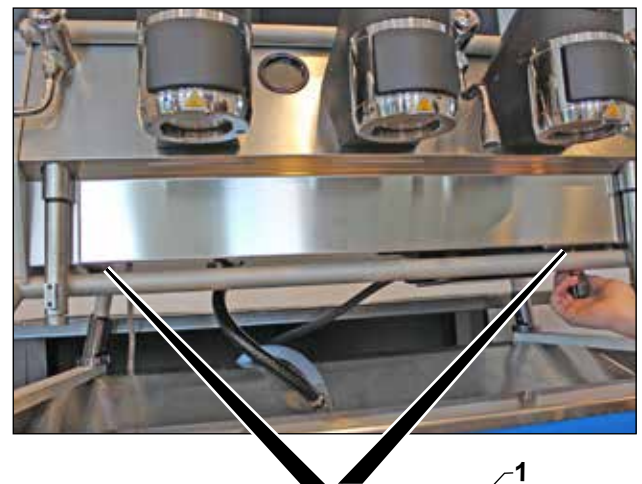

- Pull out panel (2).



5. LAYOUT OF MAIN COMPONENTS

5.1 Top view

- 1) Unit "1" boiler
- 2) Unit "2" boiler
- 3) Unit "3" boiler
- 4) Unit "1" displacement counter
- 5) Unit "2" displacement counter
- 6) Unit "3" displacement counter
- 7) Unit "1" pre-infusion solenoid valve
- 8) Unit "2" pre-infusion solenoid valve
- 9) Unit "3" pre-infusion solenoid valve
- 10) RH steam tap shut-off tap
- 11) LH steam tap shut-off tap
- 12) Service boiler
- 13) Steam pressure transducer
- 14) Safety valve
- 15) Pump motor
- 16) Water pump
- 17) Drain solenoid valve
- 18) Unit 1 shut-off tap
- 19) Unit 2 shut-off tap
- 20) Unit 3 shut-off tap

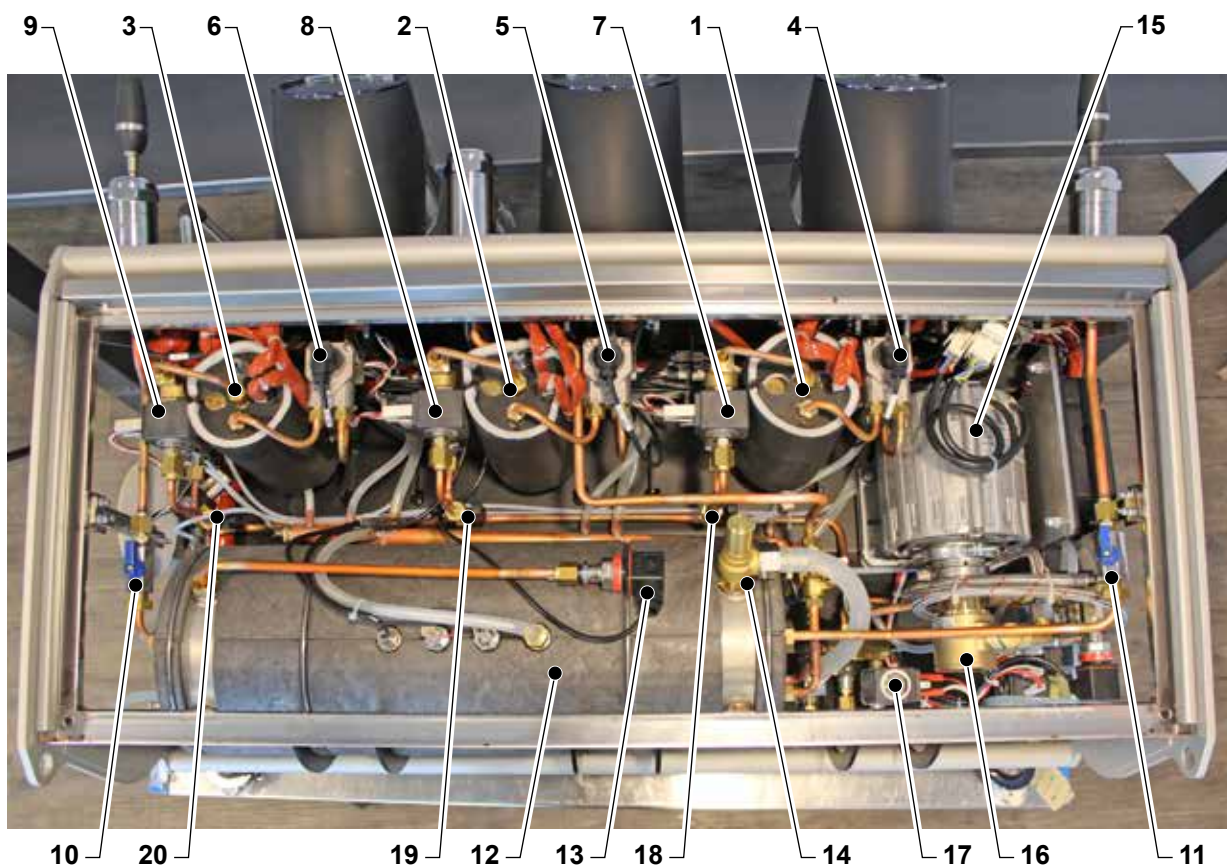

EN

5.2 Rear view

- 1) Service boiler
- 2) Drain manifold
- 3) Cooling cycle solenoid valve (boiler water regeneration)
- 4) Steam boiler drain tap
- 5) Mixed water solenoid valve

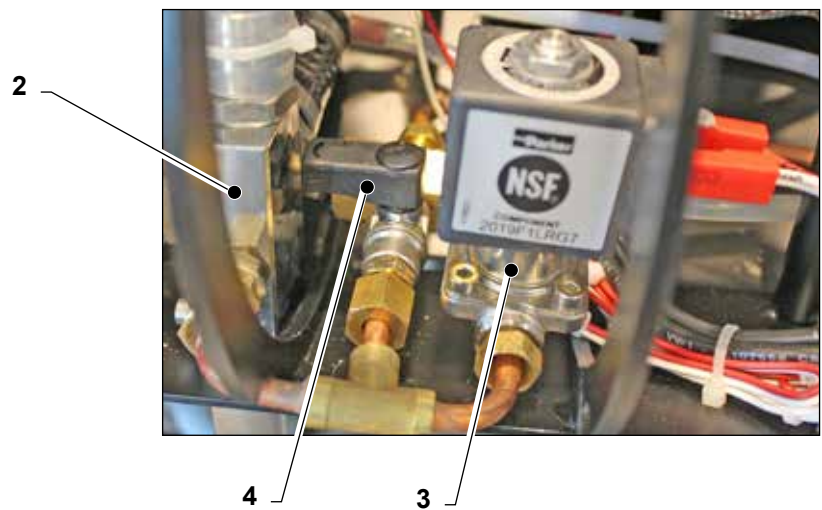
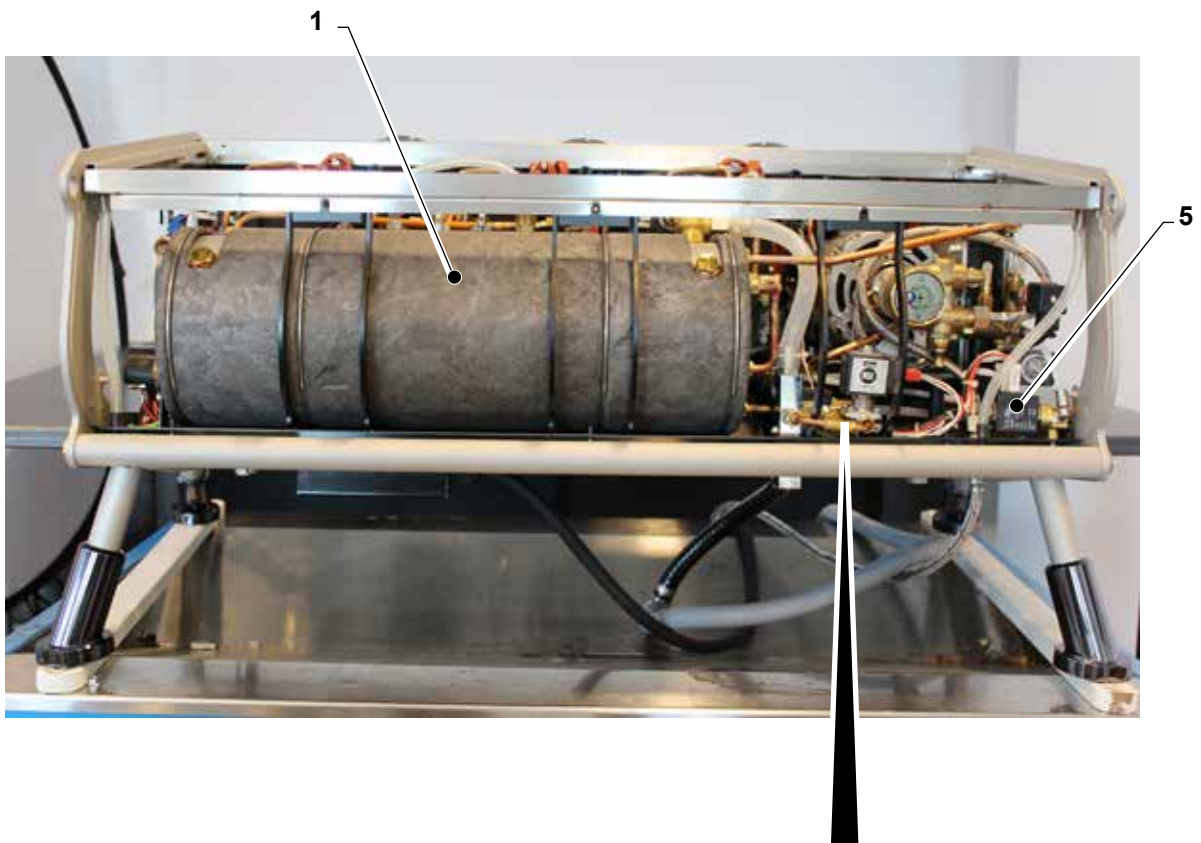

EN

5.3 LH side view

- 1) Loading flange
- 2) Pump pressure transducer
- 3) Water loading solenoid valve
- 4) LED plate
- 5) Main electronic control unit
- 6) Pre-infusion expansion board
- 7) Front and side LED on/off switch

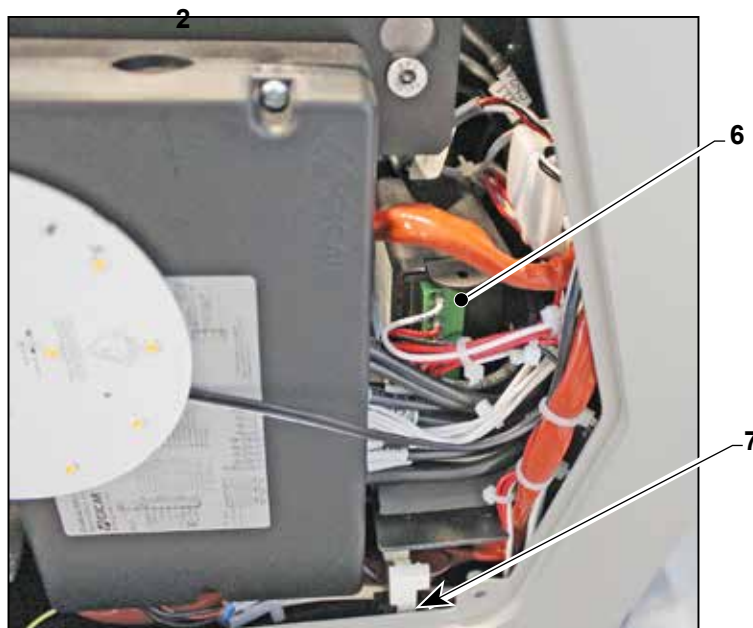
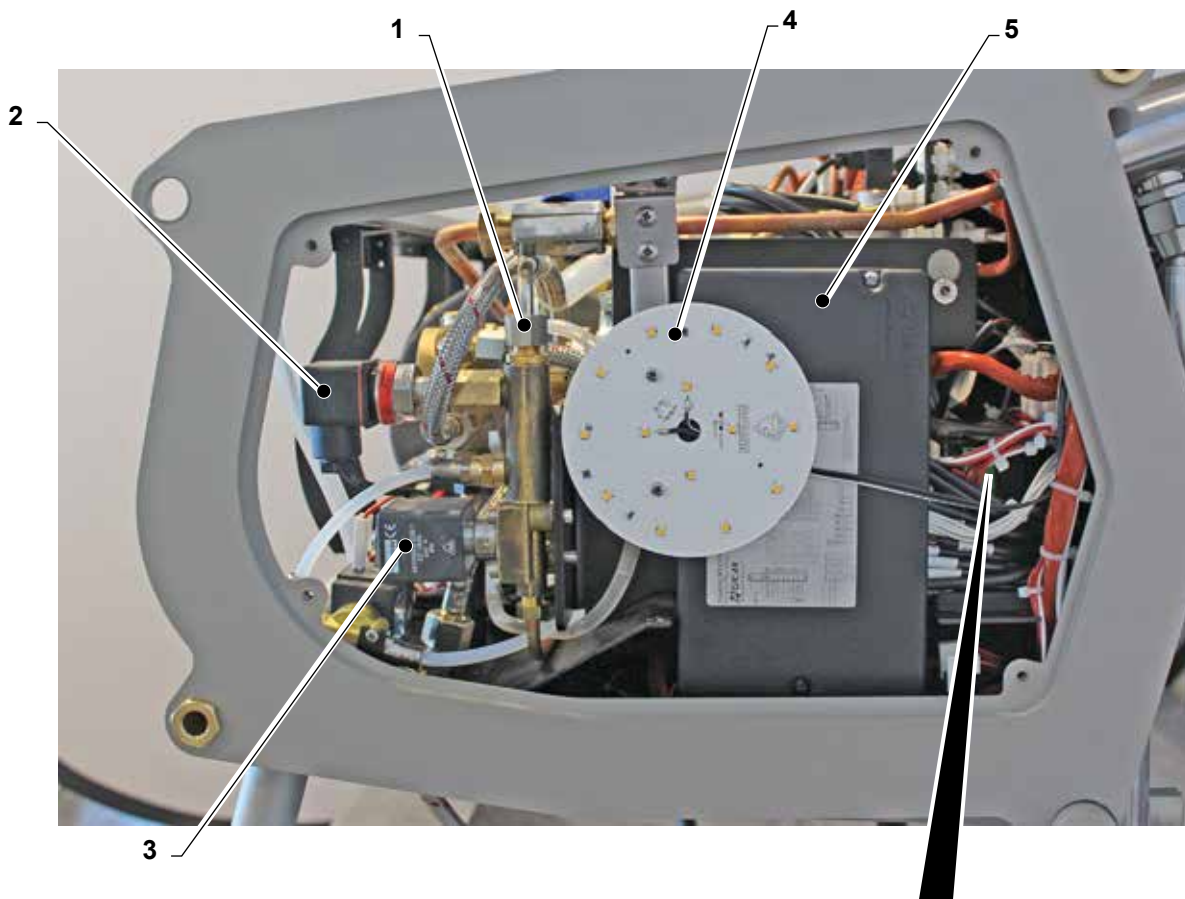

EN

5.4 RH side view

- 1) "Purge" drain connections
- 2) "Purge" button
- 3) "Purge" solenoid valve
- 4) Expansion valve
- 5) LED plate
- 6) Boiler heating elements

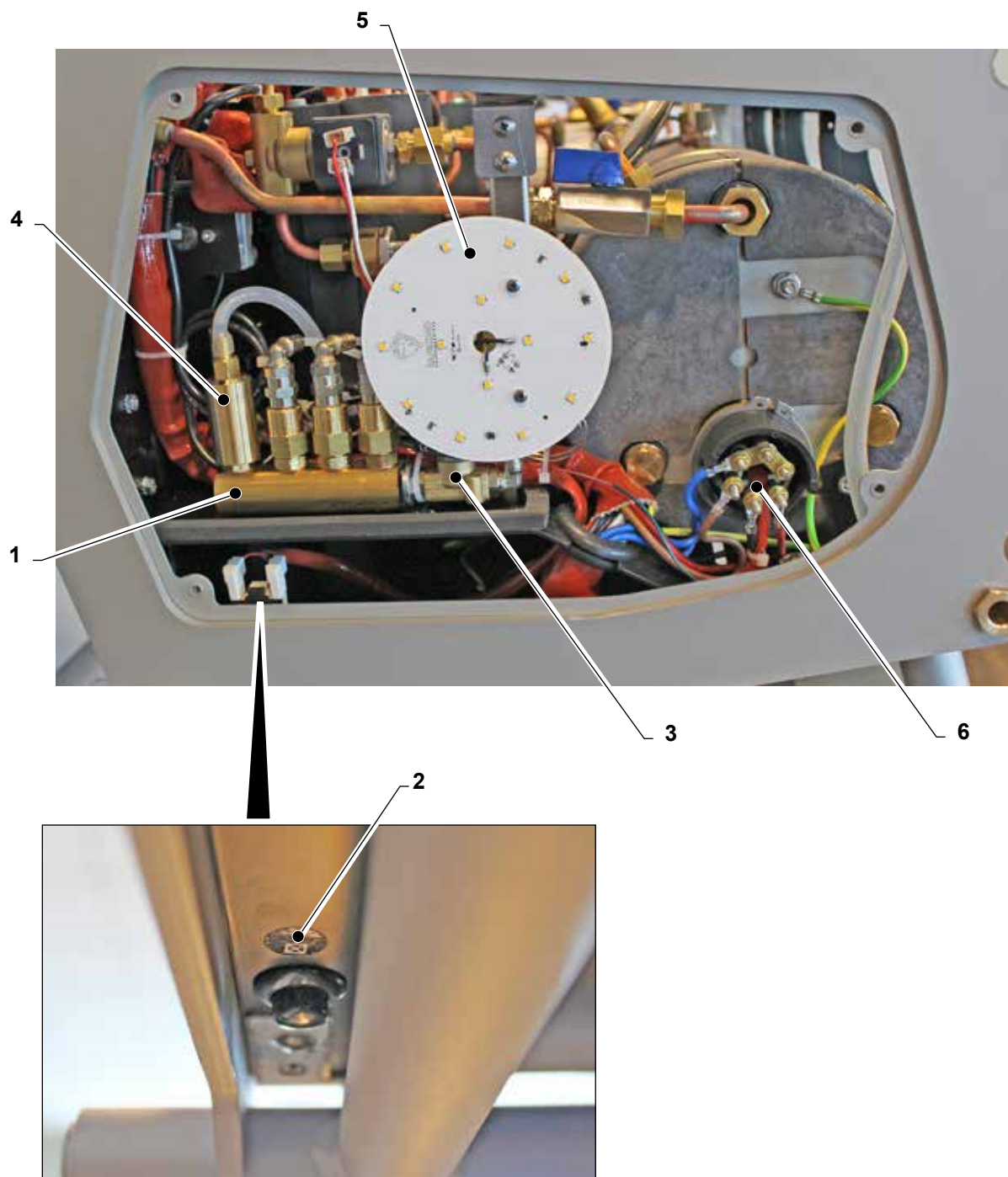

5.5 Removing the electrical panel

Remove the lower front panel as described in the relevant paragraph

- Unscrew the two knobs (1) located under the front of the machine.



- Pull out the electrical panel (2).

5.6 Layout of the electrical panel

- 1) Power relay
- 2) Triac board (unit heating and small boiler pre-heating)
- 3) High voltage self-centring connector
- 4) Single phase static relays to control steam boiler heating
- 5) Condenser
- 6) WIFI interface board (optional)
- 7) Power unit cooling fan
- 8) Switching power unit (stabilised transformer)
- 9) Fuse "F2" 3.15 A - LED fuse
- 10) Fuse "F1" 1 A - Control unit fuse

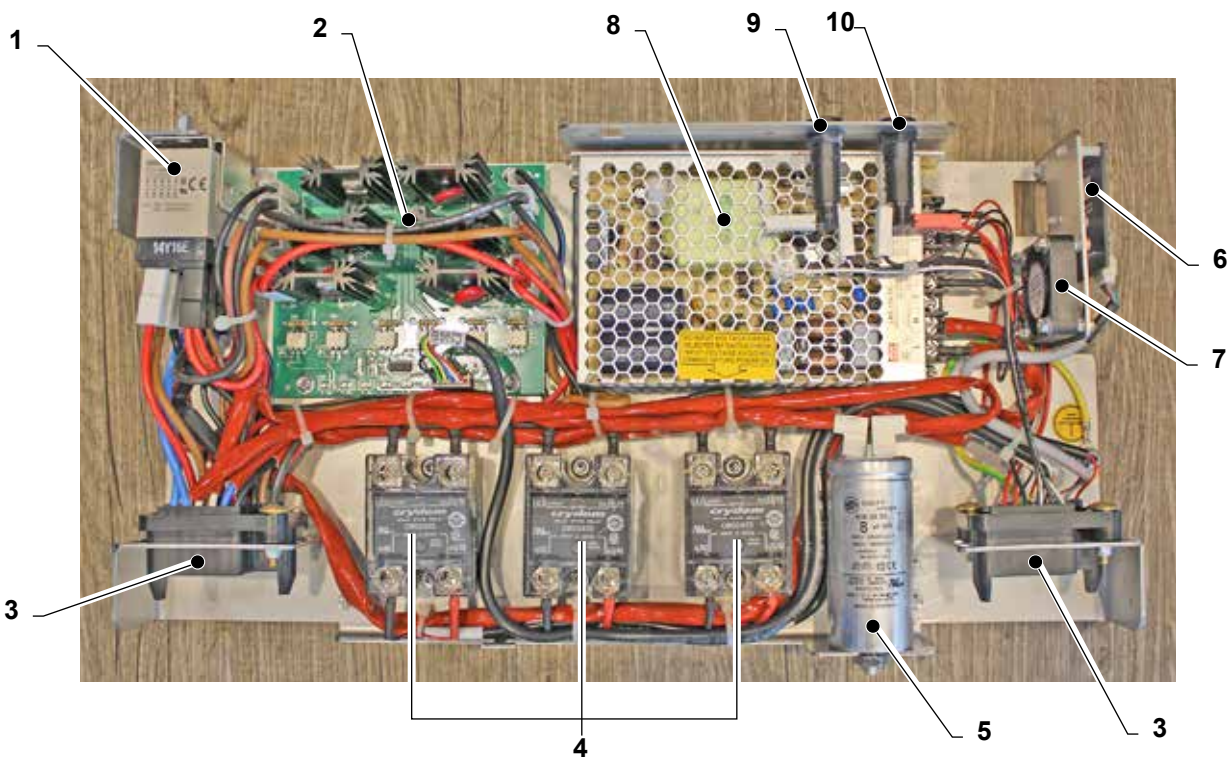
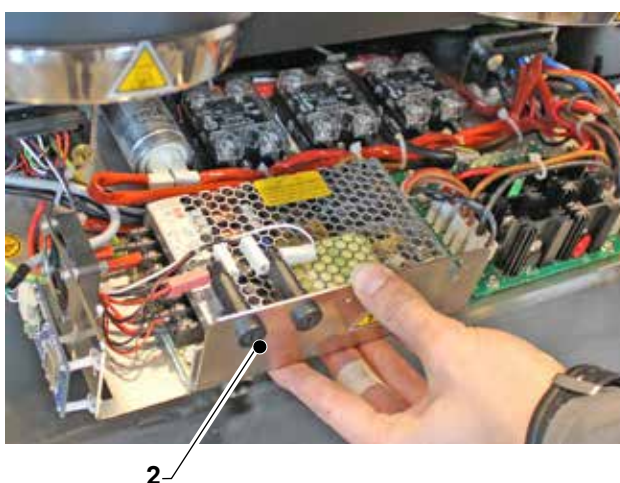

EN

6. ADJUSTMENTS AND RESETS

6.1 Adjusting mixed water

- Act on the screw (1) of the mixed water solenoid valve located in the left rear lower part, to adjust the amount of cold water that is mixed with hot water during water dispensing.



6.2 Bleeding the air from the circuit

- Press button (1), located in the right front lower part, to energise the coils and bleed any air from the circuit.
- Keep the button pressed until only water comes out of the drain, not water mixed with air.

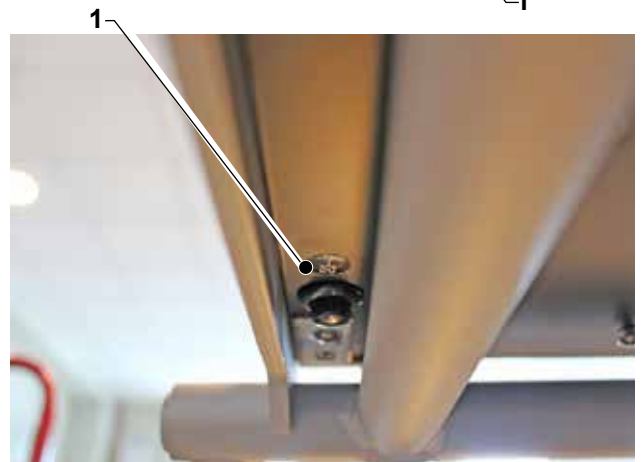

6.3 Resetting the service boiler safety thermostat

- Remove the RH side panel as described in the relative paragraph.
- Press the safety thermostat (1) to reset it.

 **If the thermostat trips again when the machine is restarted after re-setting the safety thermostat, check the boiler heating elements and the other thermostats in the machine.**

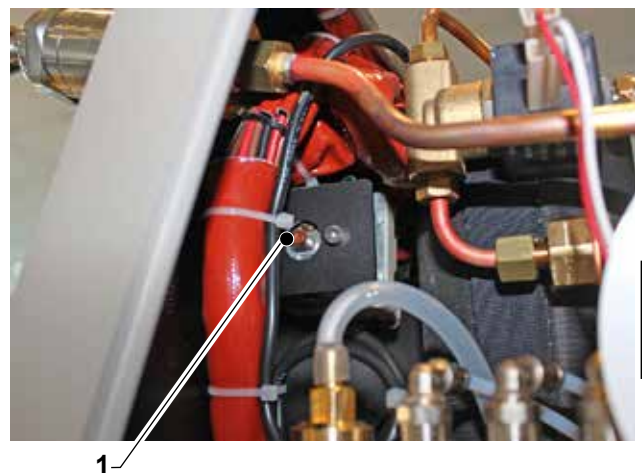

6.4 Resetting the small boiler safety thermostat

- Remove the cup heating plate as described in the relevant paragraph.
- Press the safety thermostat (1) to reset it.

 **If the thermostat trips again when the machine is restarted after re-setting the safety thermostat, check the adjustment of the small boiler temperature thermostat or its proper functioning.**

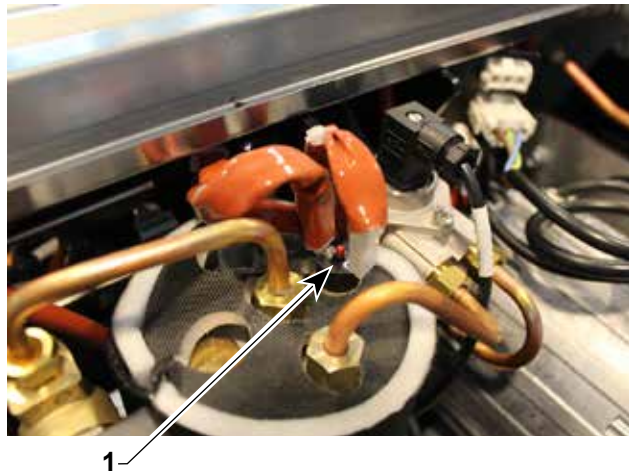

6.5 Resetting the unit safety thermostat

- Remove the unit guards as described in the relevant paragraph.
- Press the safety thermostat (1) to reset it.

 **If the thermostat trips again when the machine is restarted after re-setting the safety thermostat, check the adjustment of the small boiler temperature thermostat or its proper functioning.**



7. REMOVAL AND REPLACEMENT

7.1 Replacing the cup heating plate heating element

- Remove the cup heating plate as described in the relevant paragraph.
- Unscrew the nut (1) connecting the ground wire.

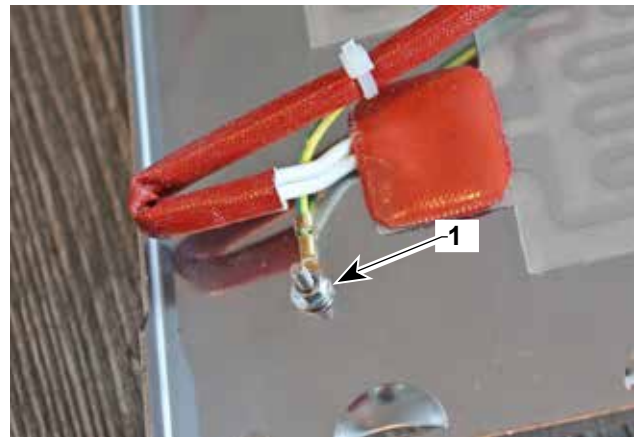

- Use a spatula to remove the adhesive heating element (2).
- Clean the surface of glue residues.
- Screw the ground nut back in and gradually place the heating element (2) on the surface so that there are no air bubbles between the surface and the heating element.

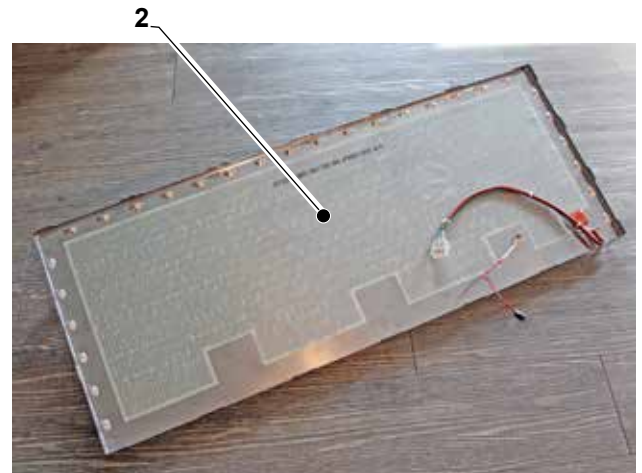

7.2 Replacing the cup heating plate probe

- Remove the cup heating plate as described in the relevant paragraph.
- Unscrew the nut (1) and remove the stopping plate (2).

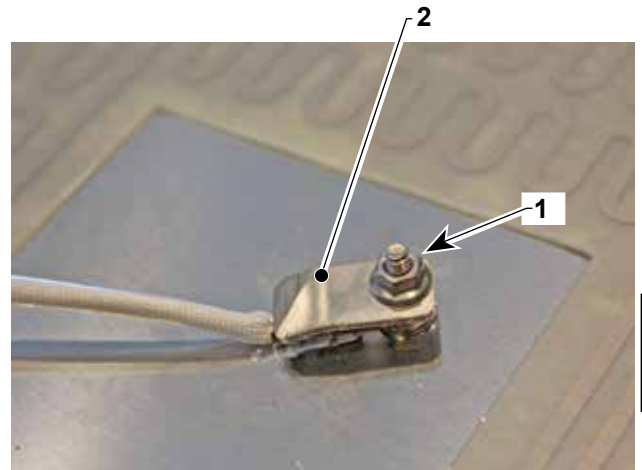

- Unscrew the nut (3) and remove the probe (4).

 **When reassembling, spread conductive paste between the probe and the cup heating plate.**

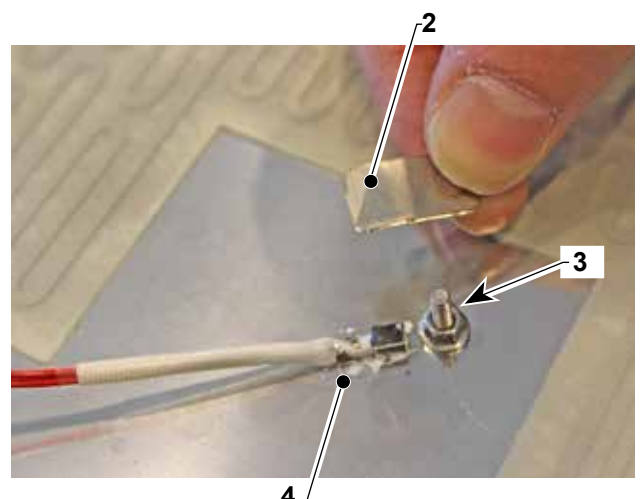

EN

7.3 Replacing the boiler heating element



Cut the power to the machine by setting the upstream main switch to OFF.

- Remove the unit guard as described in the relevant paragraph.
- Remove the lower front panel as described in the relevant paragraph.
- Ensure the machine is off and the water supply tap is closed.
- Drain the coffee circuit by opening the tap (1) of the boiler unit.

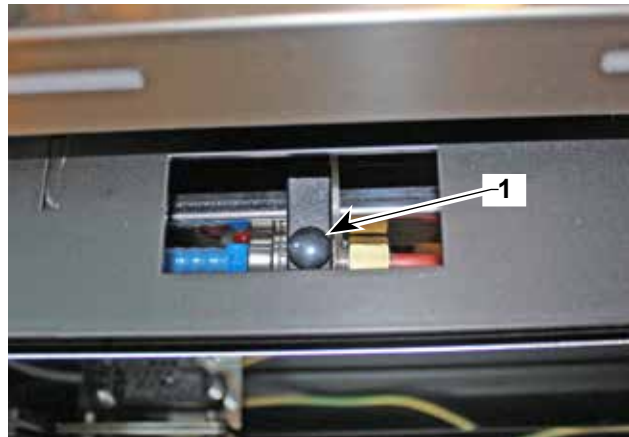

- Disconnect the two Faston connectors (2) from heating element (3).

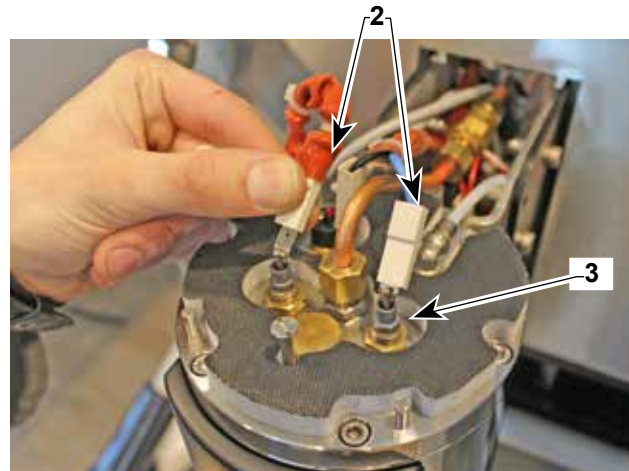

- Disconnect the water drain tube (4); press the ring nut and pull the tube.

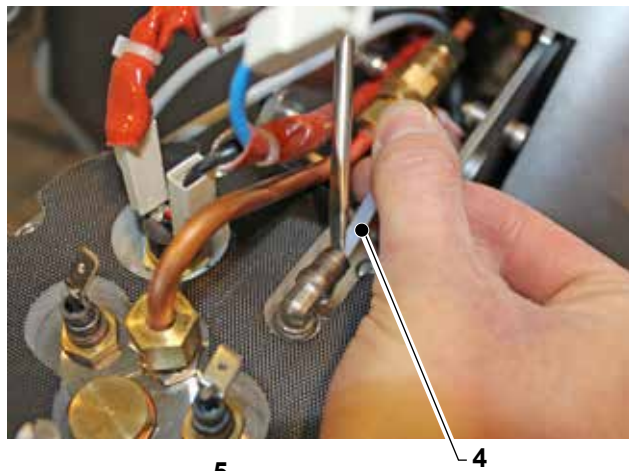

- Unscrew the nut (5) of the water supply tube.

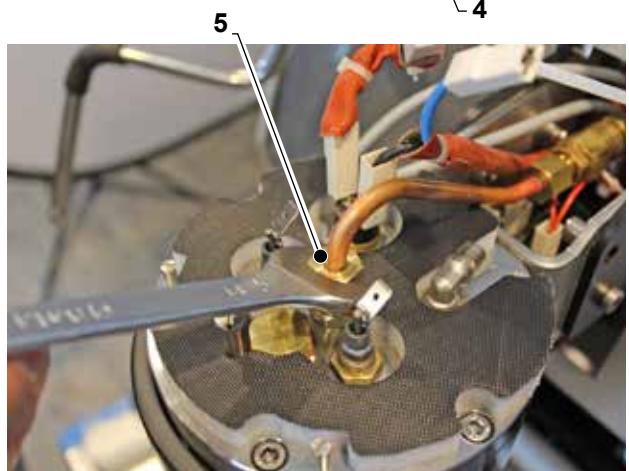

EN

- Unscrew the screws (6) fastening the boiler cover.

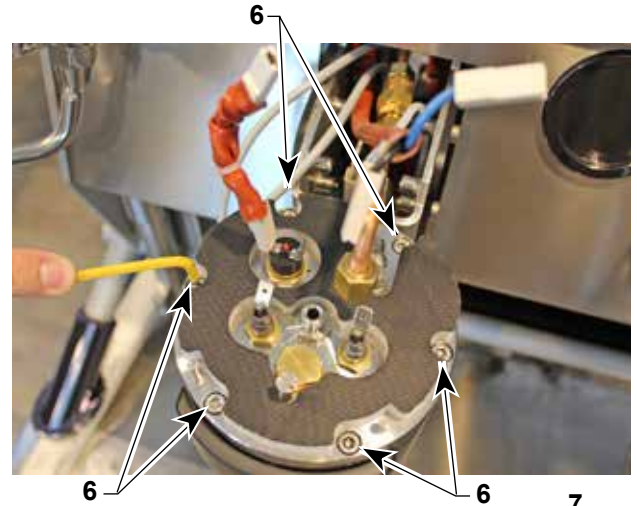

- Use a plastic hammer to tap the cover (7) to facilitate its removal.



- Remove the cover (7).



- Unscrew the nuts (8) and replace the heating element (9).

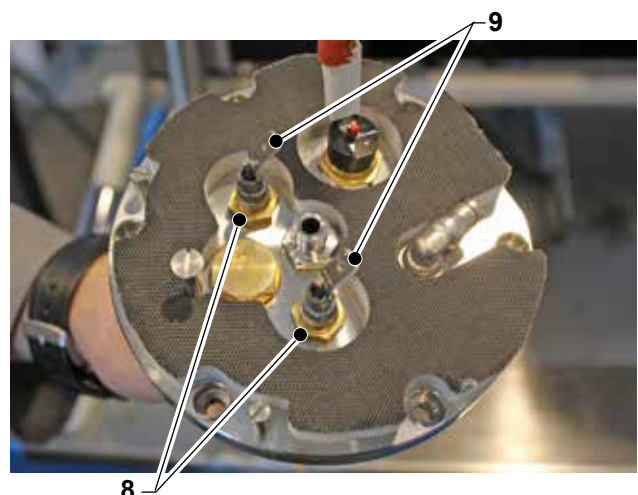



Refit everything operating in reverse order from removal checking the condition of the gasket (10) and replacing it if it is worn. Check proper electrical connection of the heating element and of the safety thermostat.



7.4 Replacing the boiler thermostat

- Remove the boiler cover (1) as described in paragraph "Replacing the boiler heating element".
- Unscrew the nut (2) and remove the thermostat (3).



When reassembling, spread conductive paste on the contact surfaces between the thermostat (3) and the cover (1).

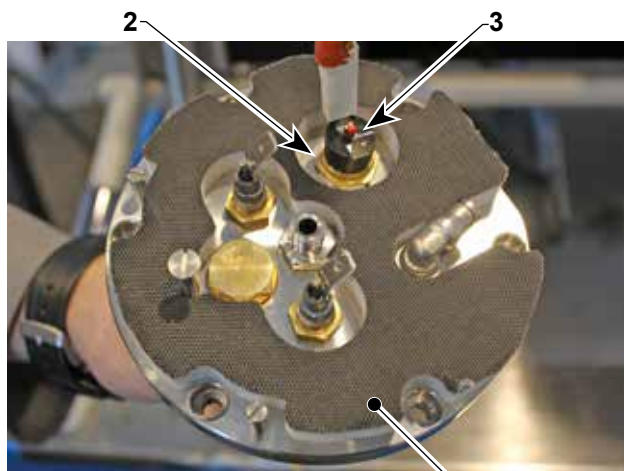

7.5 Unit boiler replacement.

- Remove the cup heating plate and the front panel as described in the relevant paragraphs.
- Drain the coffee circuit of the boiler to be removed by opening the relevant tap (1).

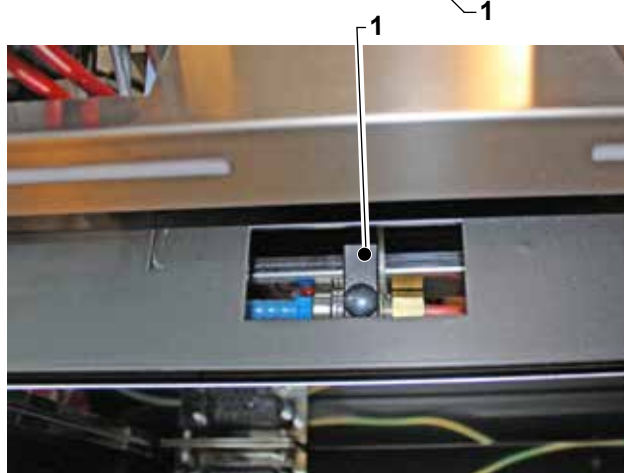

- Disconnect the boiler electrical connections (2). (3).

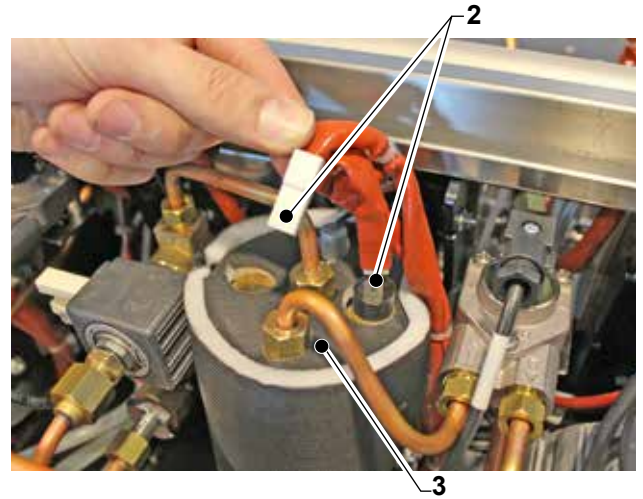

- Disconnect the probe connector (4).

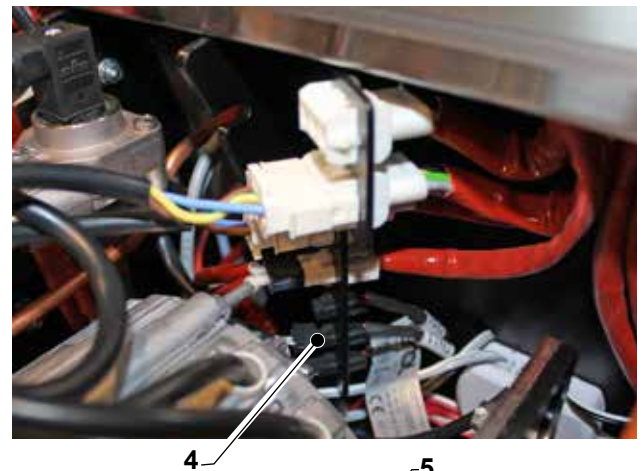

- Unscrew the two water connection tubes (5).

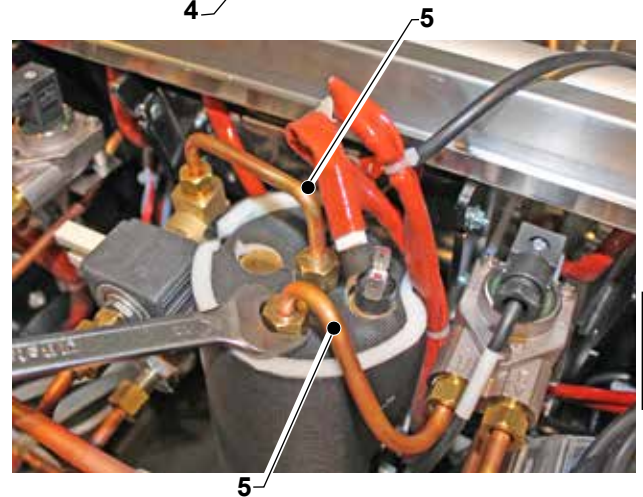

- Loosen the nuts (6), lift it and detach it from the support bracket (7).

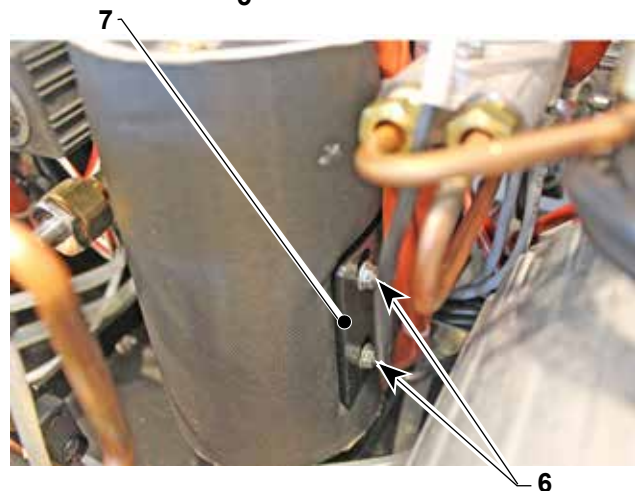

EN

- Disconnect the connectors (8) of the heating element and unscrew the nut (9) connecting the drain tap.
- Replace the boiler by operating in inverse order of removal, reconnecting the electrical cables according to the attached wiring diagram.

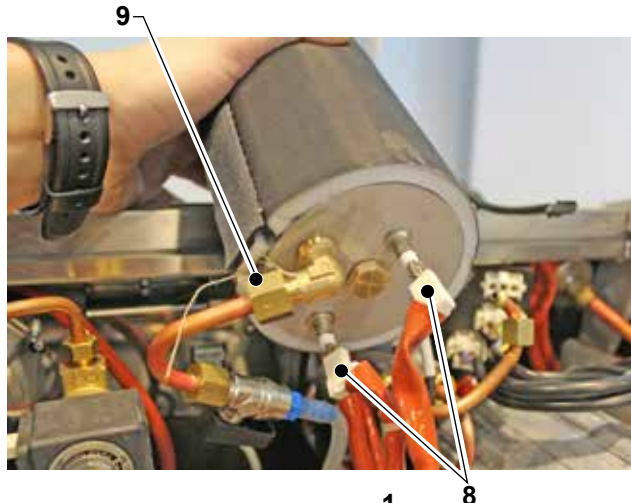

7.6 Replacing the coffee boiler heating element



Cut the power to the machine by setting the upstream main switch to OFF.

- Remove the RH side panel and the cup heating plate as described in the relevant paragraphs.
- Open the tap (1) to drain the water from the boiler (2).
- Disconnect all wires connecting the heating element (3) to the machine wiring, unscrewing the relevant nuts (4).

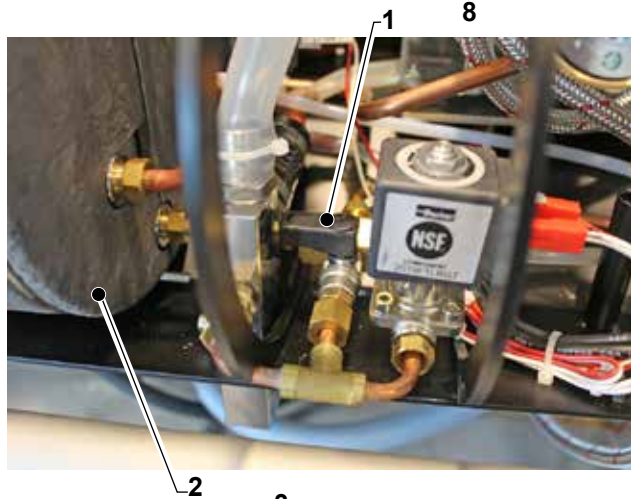

ment (3) to the machine wiring, unscrewing the relevant nuts (4).

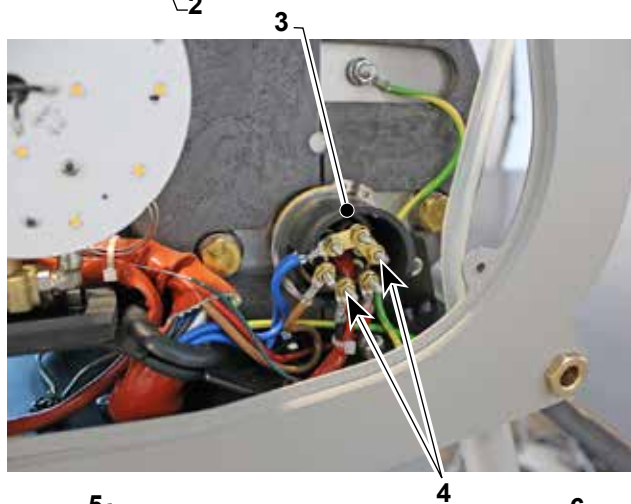

EN

- Remove the Seeger ring (5) and guard (6).
- Remove the heating element (3).
- Refit everything operating in reverse order from removal checking the condition of the heating element and replacing it if it is worn.
- Connect the wiring following the instructions on the wiring diagram attached to this manual.

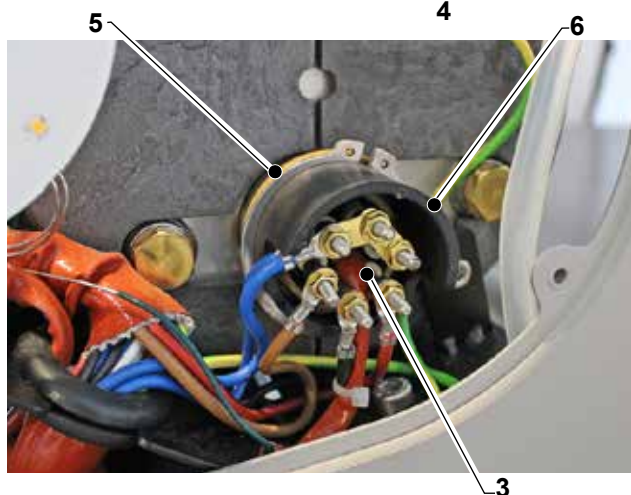

7.7 Replacing the pump

- Remove the cup heating plate as described in the relevant paragraph.
- Disconnect the pump from tubes by unscrewing nuts (1) and (2).



- Loosen the strap (3).

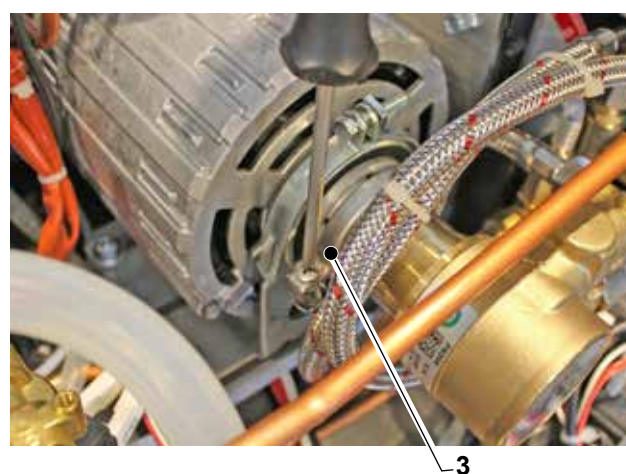

- Remove the complete pump (4):
When reassembling, pay attention to properly fit the pump pin onto the crankshaft.



When reassembling, pay attention to properly fit the pump pin onto the crankshaft.

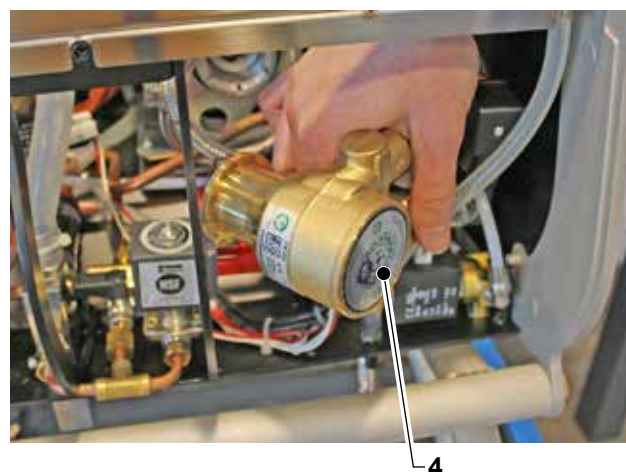

7.8 Replacing the pump motor

- Remove the cup heating plate and the LH side panel as described in the relevant paragraphs.
- Remove the pump as described in the relevant paragraph without disconnecting the intake and delivery pipes.
- Unscrew the two screws (1) and move the LED plate (2) with the relevant bracket (3).

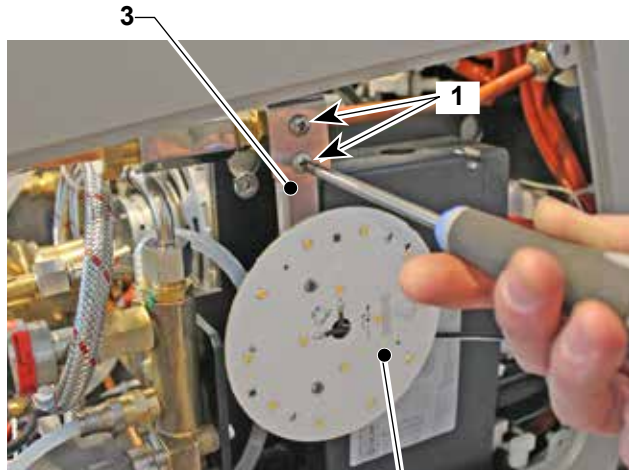

- Loosen the screws (4) fastening the pump to the plate (5).

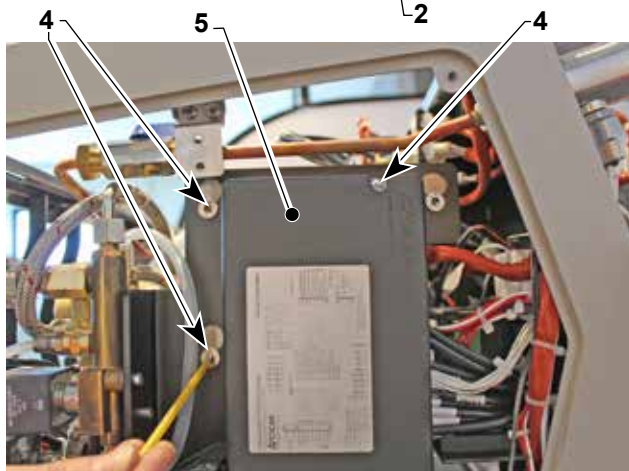

- Disconnect the two pump connectors (6) and (7).

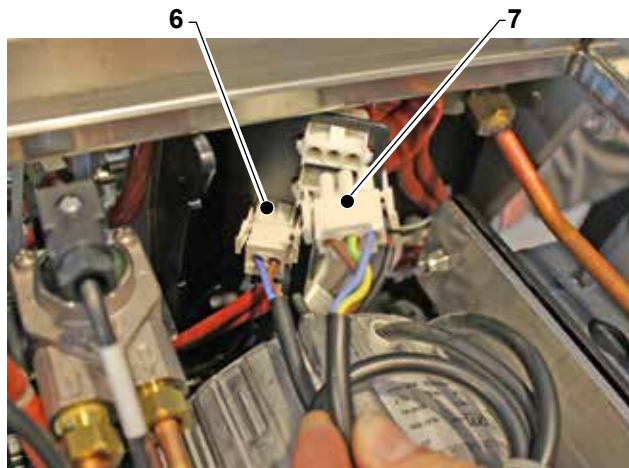

- Lift the pump motor (8) detaching it from the plate (5) and remove it.
- Reassemble everything in reverse order of removal, paying attention to connect connector (7) to the 3-way connector below it; see the wiring diagram.

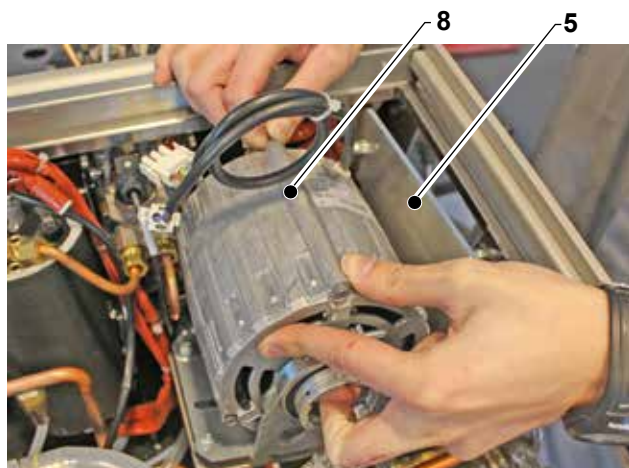

EN

7.9 Replacing the LED plate

- Remove the side panel as described in the relative paragraph.
- Unscrew the two screws (1).

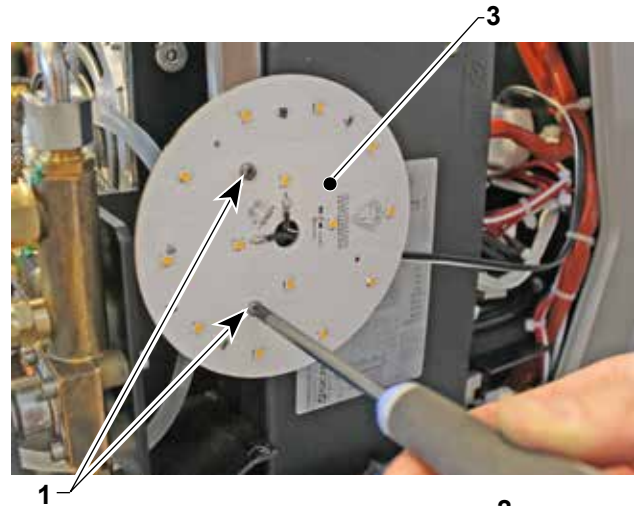

- Disconnect the connector (2) from the junction box and replace the complete plate (3).



7.10 Replacing the boiler filling solenoid valve

- Remove the LH side panel as described in the relevant paragraph.
- Disconnect the two Faston connectors (1) from the coil (2).

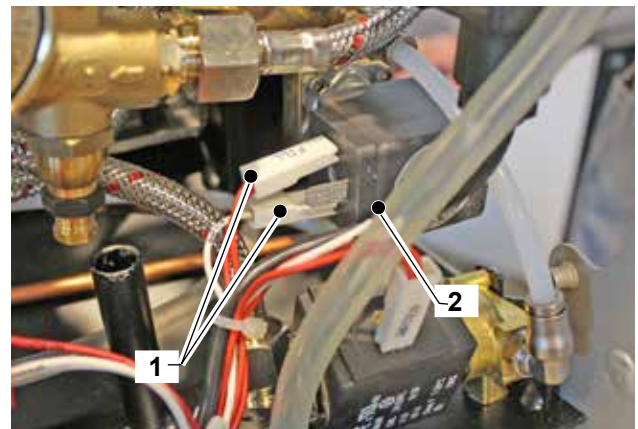

EN

- Unscrew the nut (3) of coil (2).

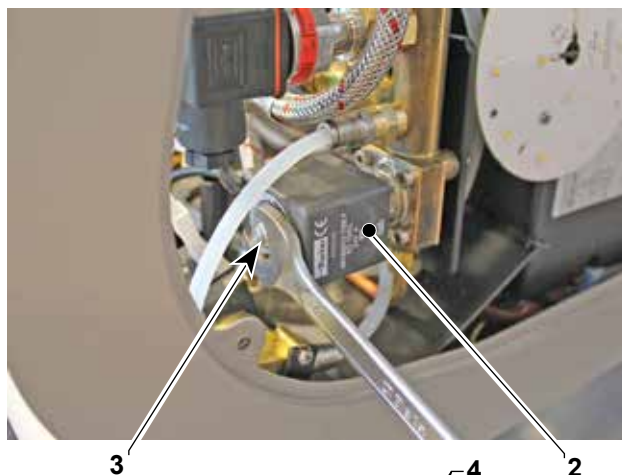

- Undo the four screws (4) and remove the core (5) of the solenoid valve.
- When reassembling, pay attention to properly connect the Faston connectors to the coil.

 **When reassembling the core, pay attention to properly reassemble the gasket, core and spring.**

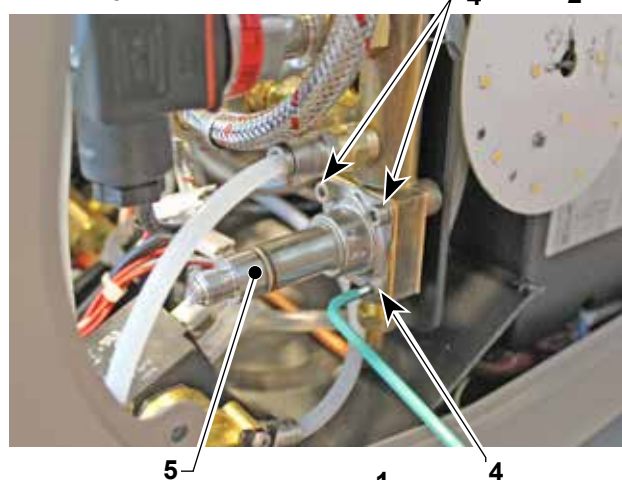

7.11 Replacing the mixed water solenoid valve

- Remove the LH side panel, the LH side profile and the rear panel as described in the relevant paragraphs.
- Unscrew the two bushings (1).

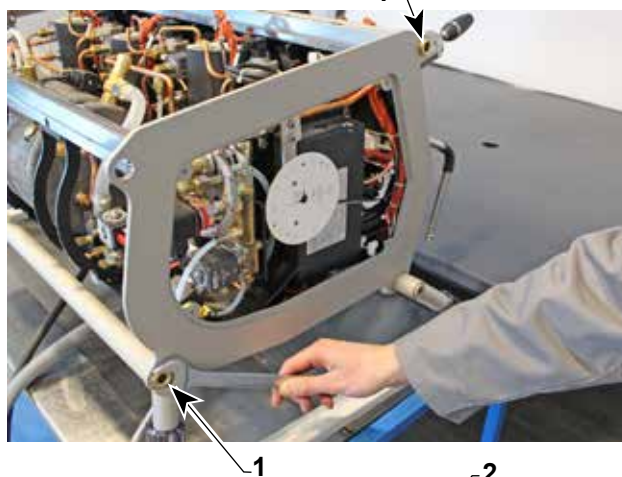

EN

- Unscrew screw (2).



- Remove the left shoulder (3).

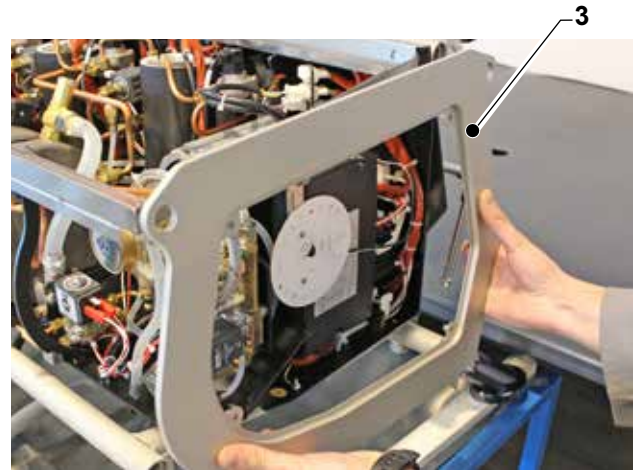

- Unscrew the screws (4) fastening the solenoid valve (5) to the bracket (6).

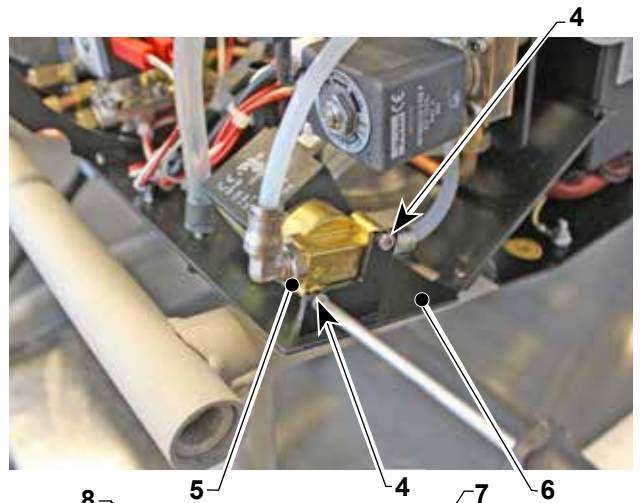

- Disconnect the two Teflon tubes (7).
- Disconnect the two Faston connectors (8).
- Remove the clip (9) to replace the coil or replace the entire solenoid valve (5).
- When reassembling, pay attention to properly connect the Faston connectors to the coil.

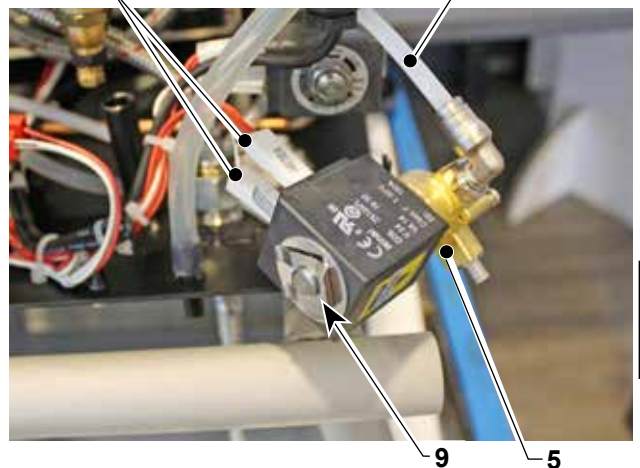

7.12 Replacing the hot water solenoid valve

- Remove the cup heating plate as described in the relevant paragraph.
- Disconnect the Faston connectors (1).
- Unscrew the two nuts (2) and remove the solenoid valve (3).
- Replace the coil or solenoid valve and reassemble in inverse order of removal.

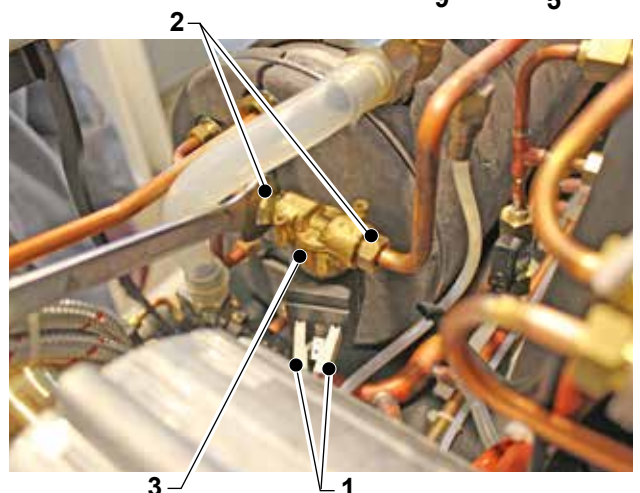

EN

7.13 Replacing the cooling cycle solenoid valve

- Remove the cup heating plate as described in the relevant paragraph.
- Disconnect the Faston connectors (1).

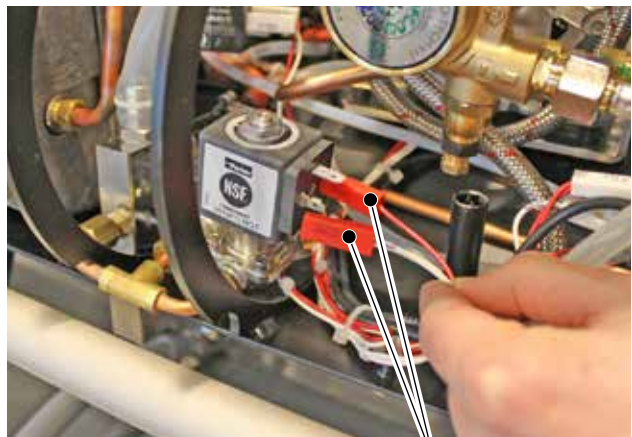

- Unscrew the nut (2) and remove the coil (3).

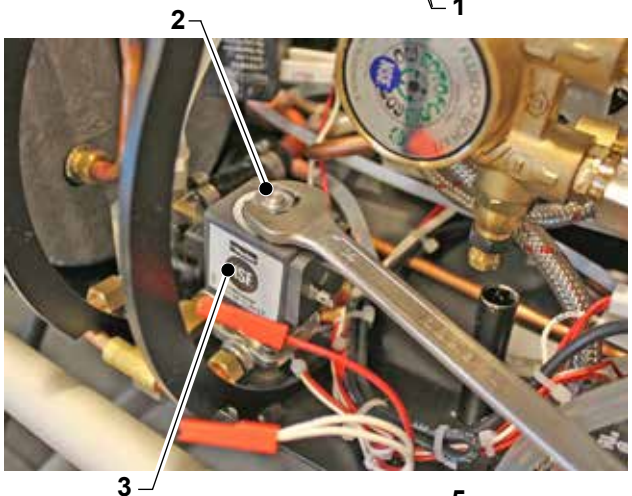

- Undo the four screws (4) and remove the core (5).
- When reassembling, pay attention to properly connect the Faston connectors to the coil.

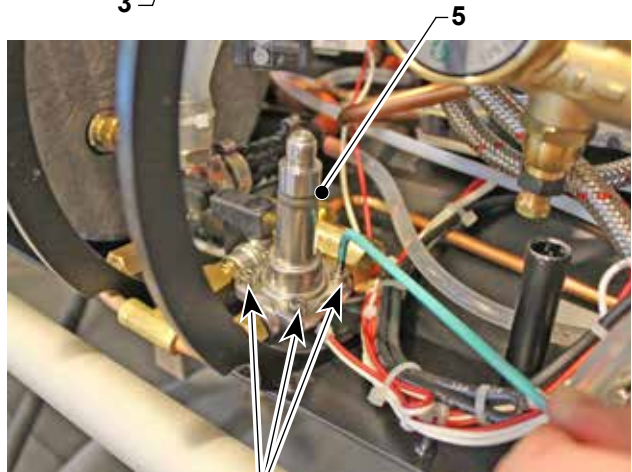

 **When reassembling the core, pay attention to properly reassemble the gasket, core and spring.**

EN

7.14 Replacing the purge solenoid valve.

- Remove the RH side panel as described in the relative paragraph.
- Unscrew the two screws (1) and move the LED plate (2) with the relevant bracket (3).

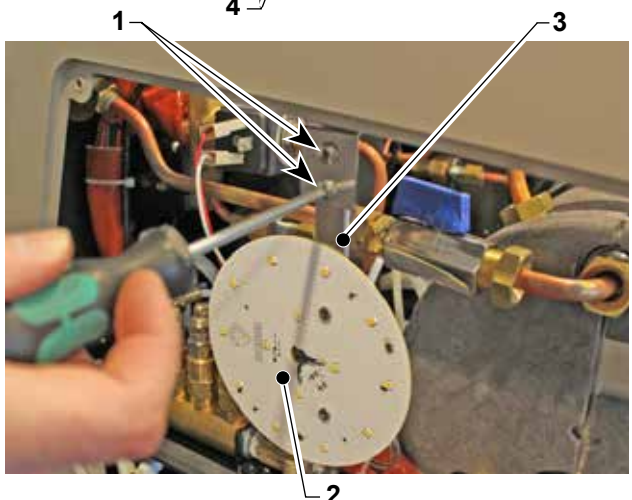

- Cut the strap (4).

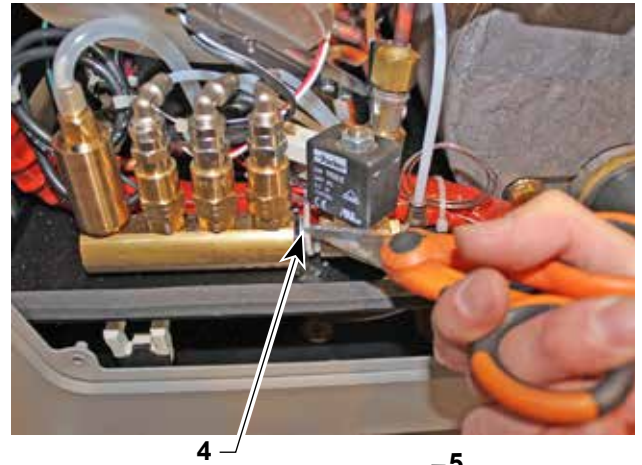

- Disconnect the tube (5).



- Loosen the nut (6) fastening the flange (7) to the bracket.

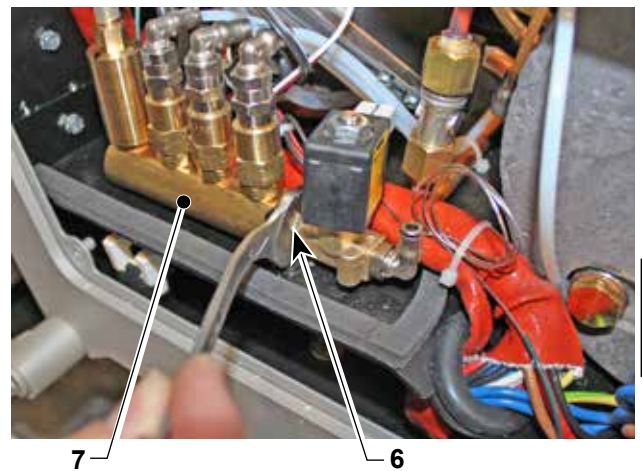

- Disconnect the Faston connectors (8).

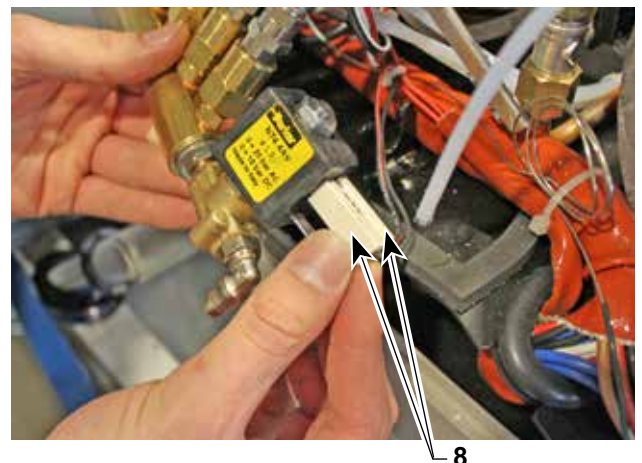

EN

- Position a spanner on the solenoid valve body (9) and unscrew it from the flange (7).
- When reassembling, pay attention to properly connect the Faston connectors to the coil and place the strap back in its original position.

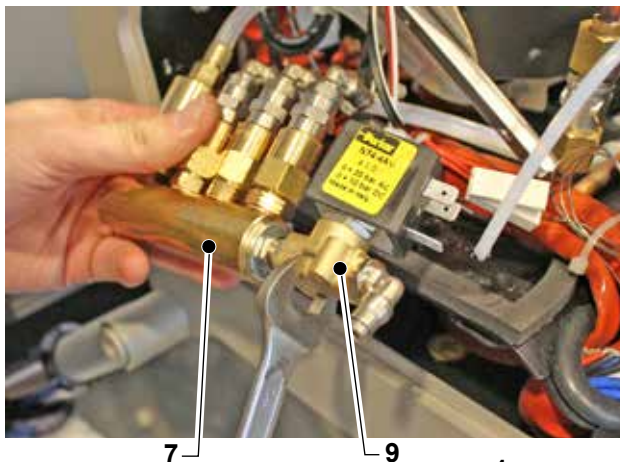

7.15 Replacing the pre-infusion solenoid valve.

- Remove the cup heating plate as described in the relevant paragraph.
- Disconnect the Faston connectors (1).



- Unscrew the three nuts/fitings (2) and remove the solenoid valve (3).
- When reassembling, pay attention to properly connect the Faston connectors to the coil.
- Unscrew the three nuts/fitings (2) and remove the solenoid valve (3).
- When reassembling, pay attention to properly connect the Faston connectors to the coil.

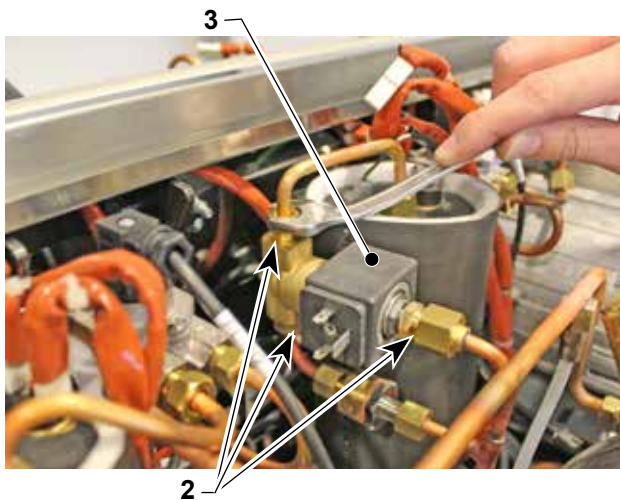

EN

7.16 Replacing the unit solenoid valve

- Remove the unit guards as described in the relevant paragraph.
- Disconnect the Faston connectors (1) with a needle-nose plier.

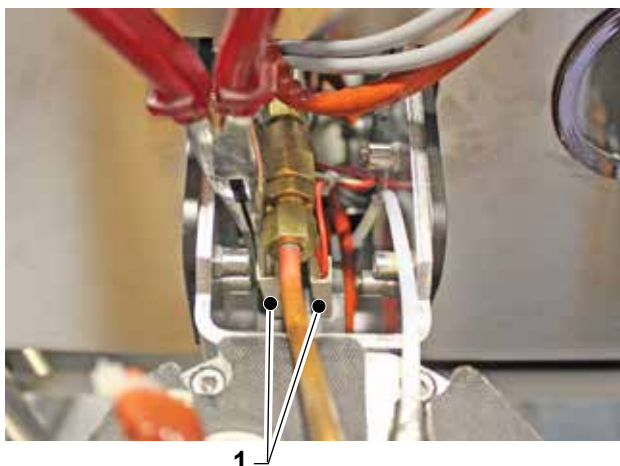

- Open the wire strap (2) and disconnect the tube (3).
- Undo the four screws (4) and remove the core with coil (5).
- When reassembling, pay attention to properly connect the Faston connectors to the coil.

 **When reassembling the core, pay attention to properly reassemble the gasket, core and spring.**

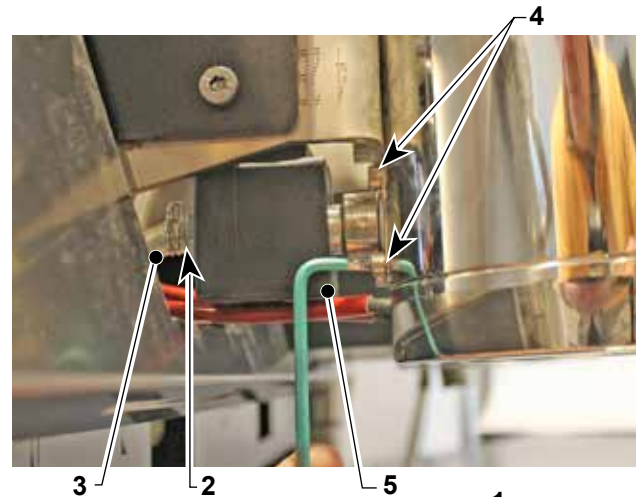

7.17 Replacing the displacement counter.

- Remove the cup heating plate as described in the relevant paragraph.
- Undo the screw (1) and remove the head (2).

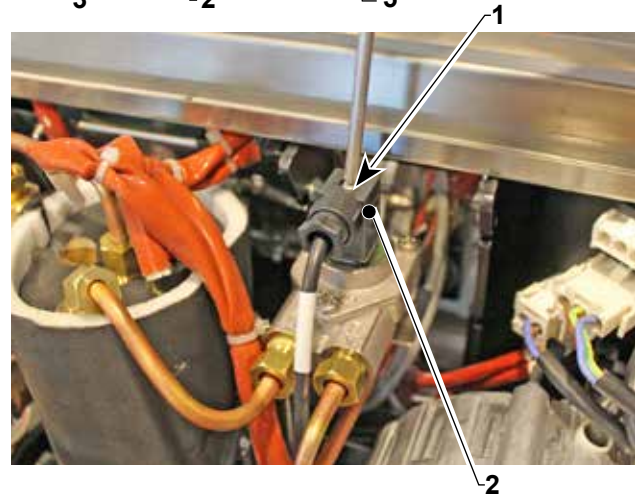

- Unscrew the nuts (3) and disconnect the tubes (4).

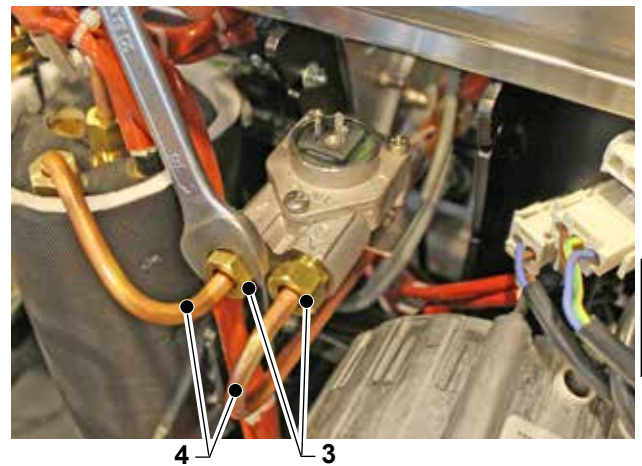

- Loosen the two nuts (5) located under the support square, then pull out the displacement counter (6).

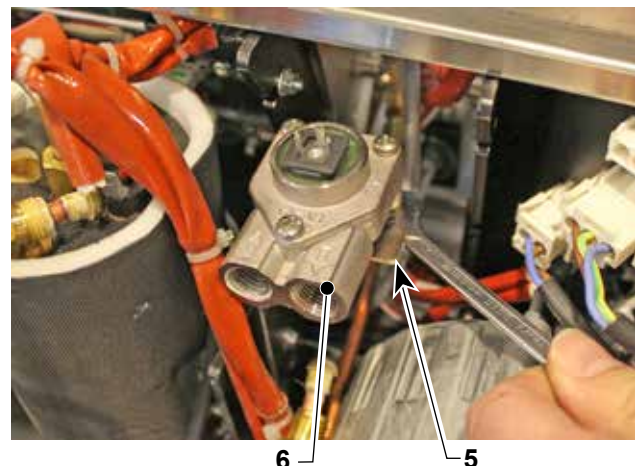

7.18 Replacing the pump pressure transducer

- Remove the left panel as described in the relevant paragraph.
- Cut the straps (1) fastening the transducer cable to the machine wiring.

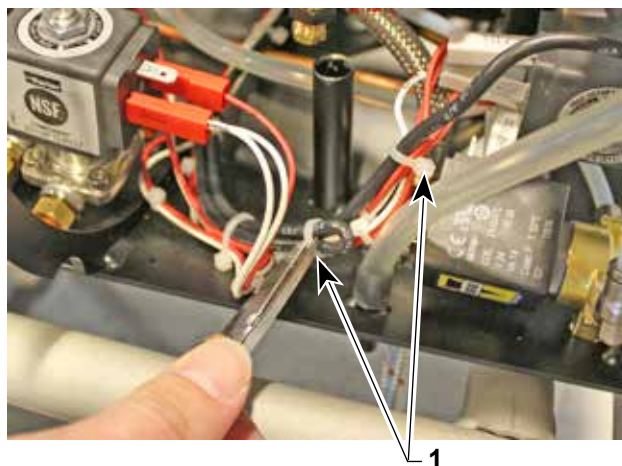

- Unscrew the transducer (2).



- Unscrew screw (3) and disconnect contacts (4) from transducer (2).

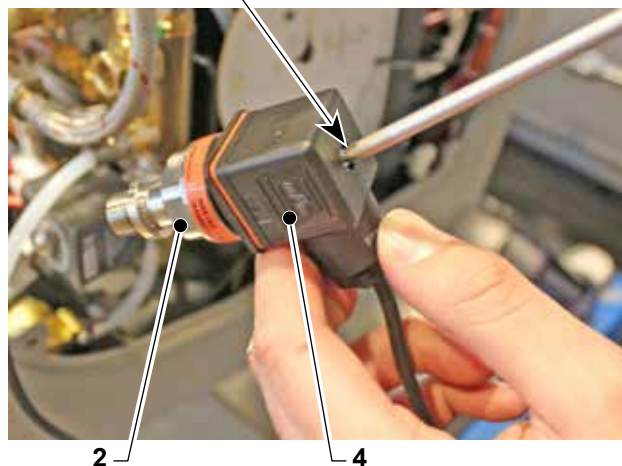

EN

7.19 Replacing the service boiler pressure transducer

- Remove the cup heating plate as described in the relevant paragraph.
- Unscrew the transducer (1).
- Unscrew screw (2) and disconnect contacts (3) from transducer (1).

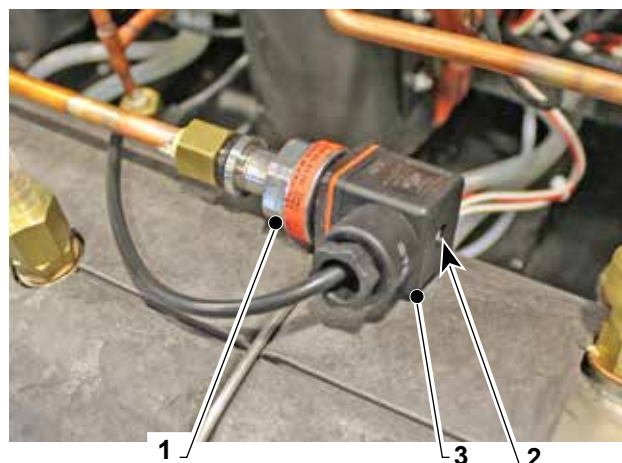

7.20 Replacing the pre-infusion expansion board

- Remove the cup heating plate and the LH side panel as described in the relevant paragraphs.
- Use a long Phillips screwdriver (1) to unscrew the fastening screw of the expansion board

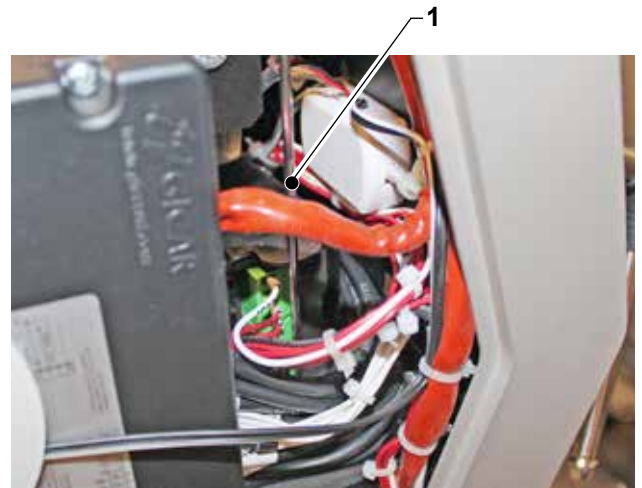

- Disconnect the connectors (2).

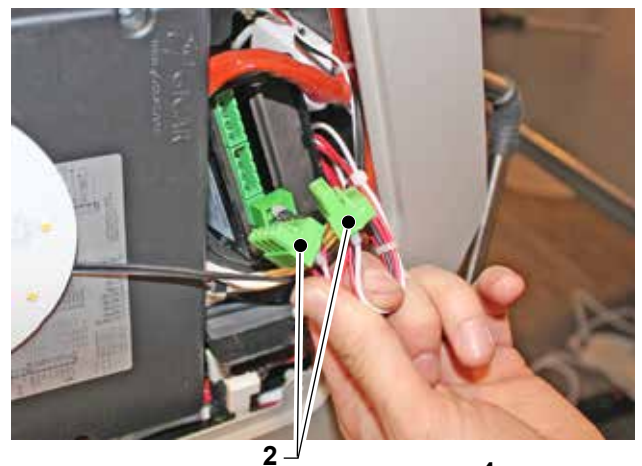

- Pull out the board (3) and disconnect the rear connector (4).

 **Mark the position of connectors so that they are inserted in the relevant seat when the board is reassembled.**

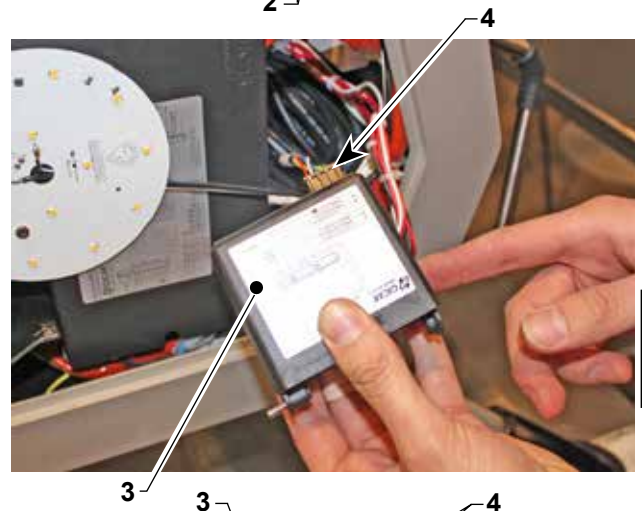

7.21 Replacing the electronic board

- Remove the LH side panel as described in the relevant paragraph.
- Unscrew the two screws (1) and move the LED plate (2) with the relevant bracket (3).

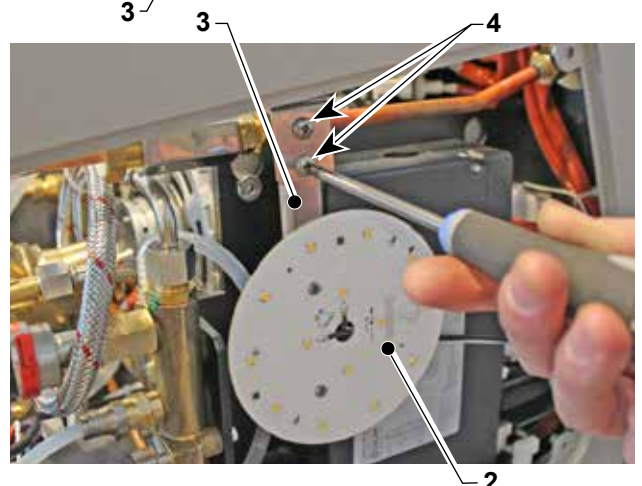

- Undo the two screws (4) and remove the cover (5) of the electronic board.

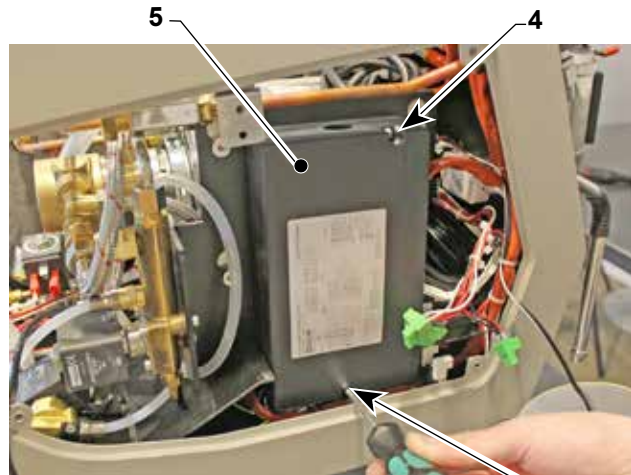

- Disconnect all connectors of board (6), unscrew the three flanged nuts (7) and remove the board.

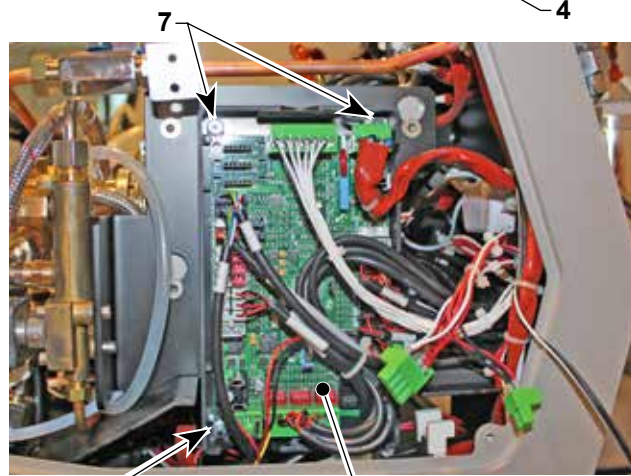

7.22 Replacing the electrical panel components



To perform this check, the electrical connection must be inserted, therefore the electrical panel components (4) are powered up. Operate with utmost care.

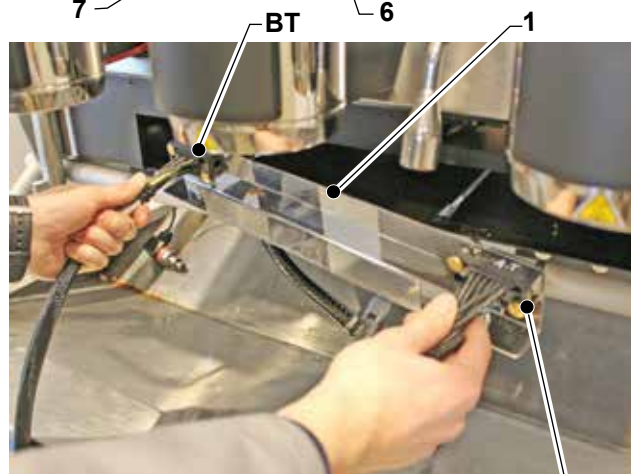

EN

- In order to check proper operation of the electrical panel components, pull the panel out and connect the relevant extension, supplied upon request.
- Remove the lower front panel as described in the relevant paragraph.
- Pull out the electrical panel as described in the relative paragraph.
- Insert the extension (1) in place of the panel into the machine.
- Connect the connector marked "AT" to connector (2), and the connector marked "BT" to connector (3).

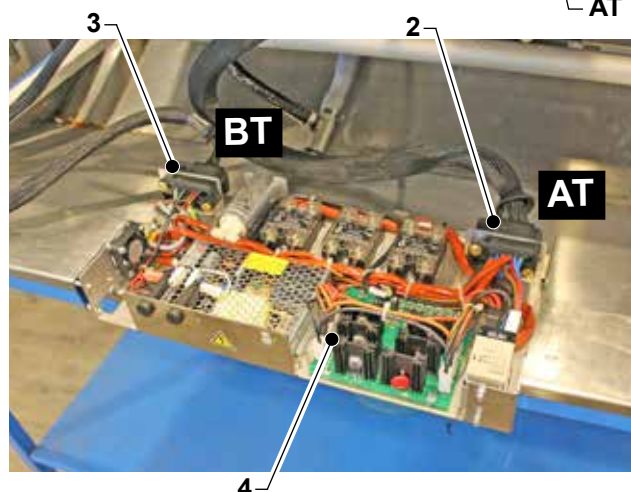

- If the plate (5) is removed, assemble the connectors as shown in the figure, paying attention to position the guide (6), for both connectors, as positioned in the figure.

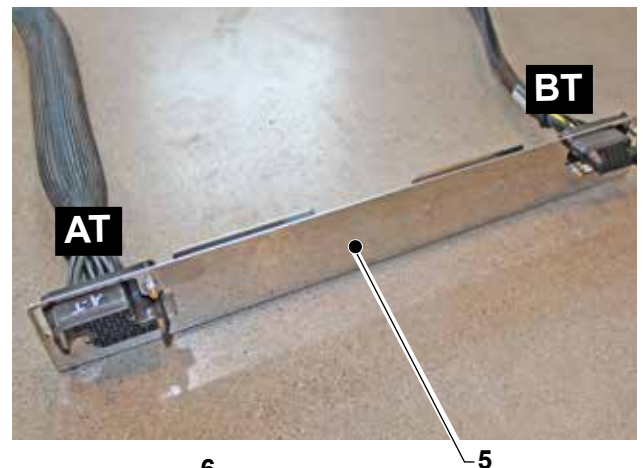

7.23 Replacing the display board

- Remove the cup heating plate as described in the relevant paragraph.
- Loosen the four nuts (1), two on each side.

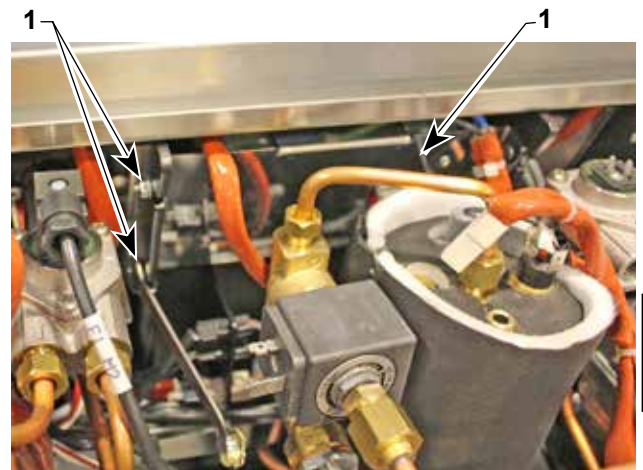

- Disconnect the connector (2).

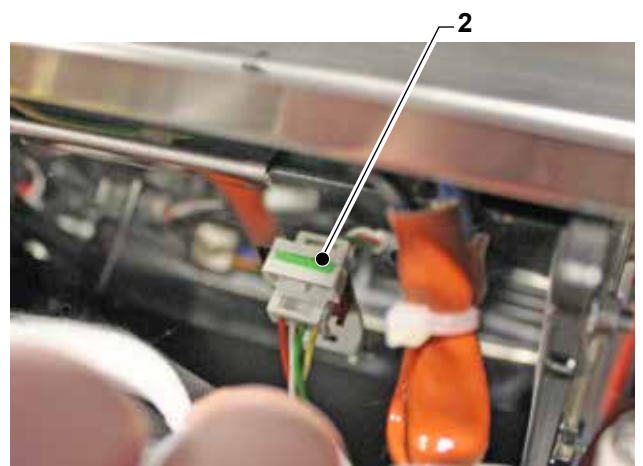

- Pull out the display board (3).

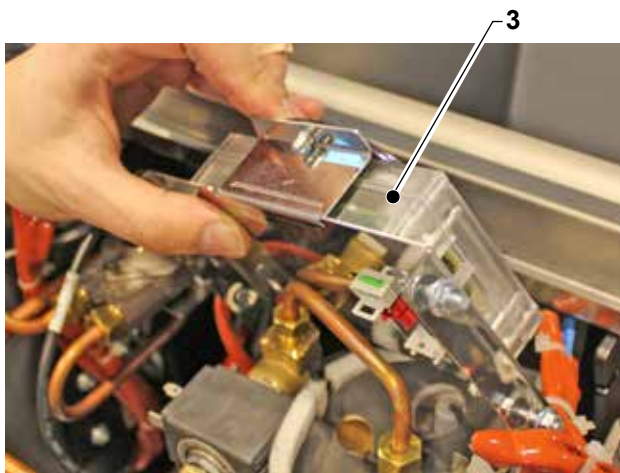

- Undo the screw (4) and remove the frame (5).
- Unscrew the two screws (6) and remove the display board (7) from bracket (8).

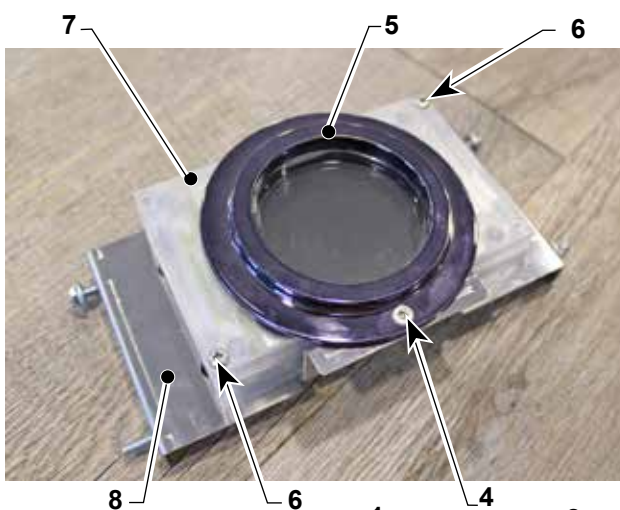

7.24 Replacing the unit display

- Remove the coffee unit guards as described in the relevant paragraph.
- Disconnect the two connectors (1) and (2) and remove the sponge (3).

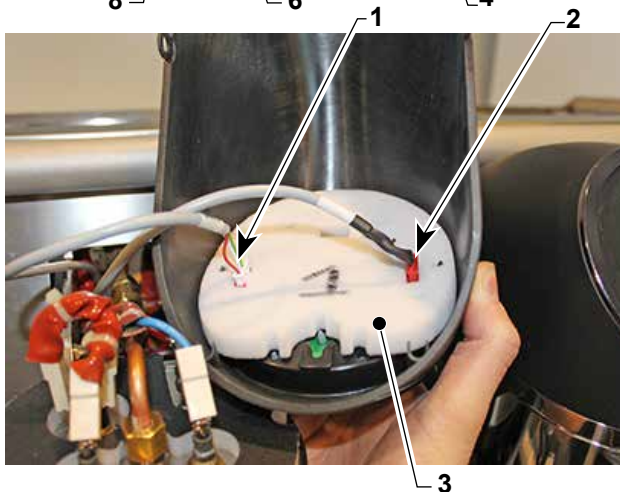

- Unscrew the three front screws (1).

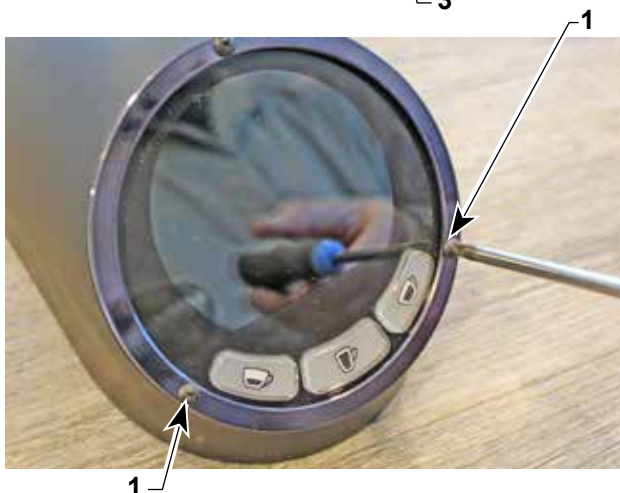

EN

- Remove the external frame (2).



- Remove the internal frame (3).

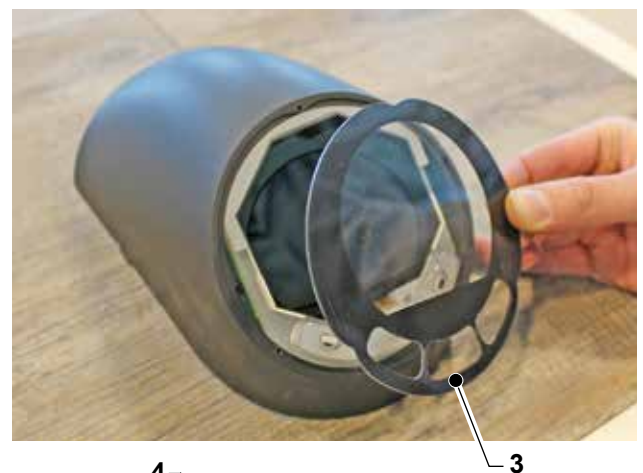

- Unscrew the two screws (4) and remove the display (5).

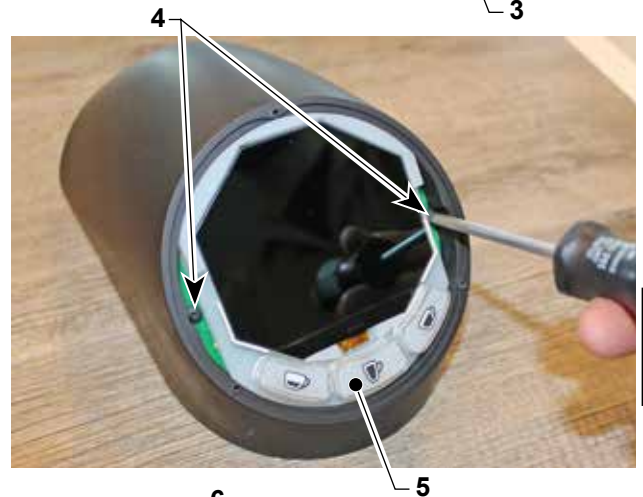

- After replacing the display, set the dip-switch (6) according to the fact that unit "1", "2" or "3" is installed; see the figure to adjust the dip-switch.

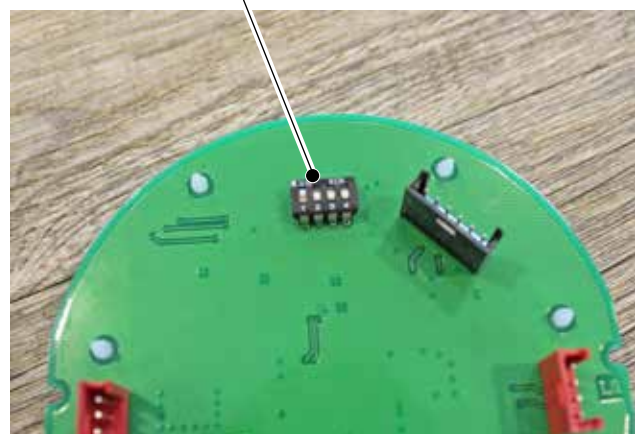
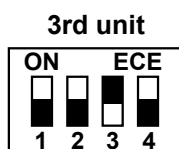
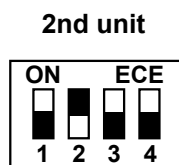
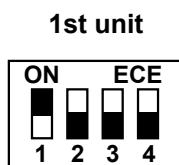

EN

7.25 Removing the service boiler

- Remove the cup heating plate and the RH side panel as described in the relative paragraphs.
- Disconnect the heating element (2) electrical connection cables (1).
- Unscrew the nut (3) and remove the ground wire (4).
- Unscrew the nut (5) and disconnect the right steam tap connection tube (6).

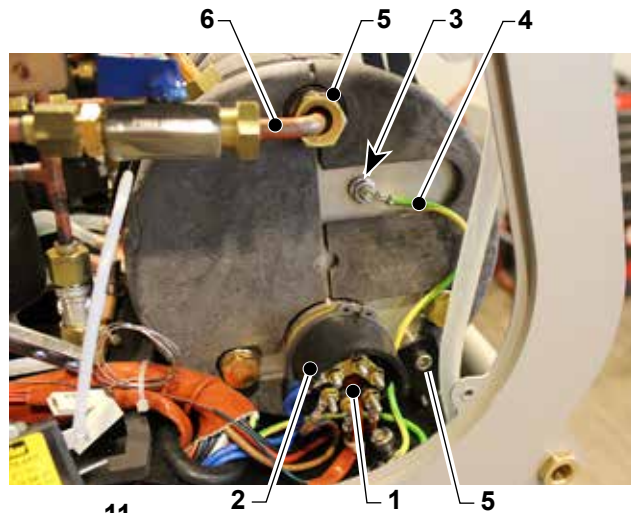

- Unscrew and remove the temperature probe (7).
- Disconnect the maximum level probe connector (8).
- Disconnect the minimum level probe connector (9).
- Unscrew the nut (10) and disconnect the air bleed tube (11).

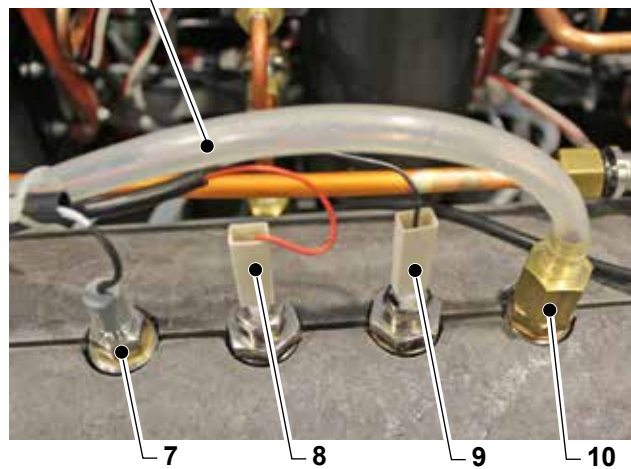

- Unscrew the nut (12) and remove the transducer tube (13).

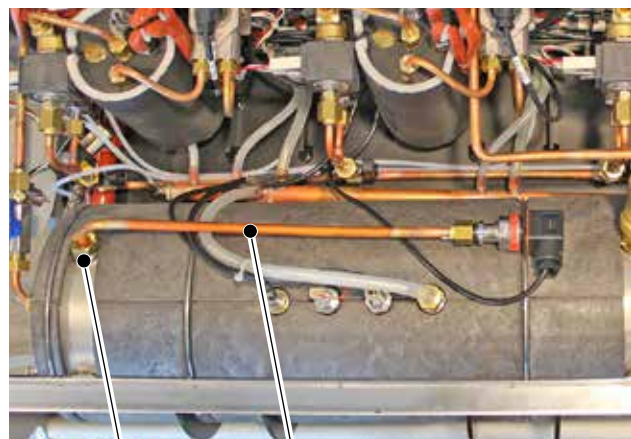

- Unscrew the nut (14) and disconnect the left steam tap connection tube (15).
- Unscrew the nuts (16) and disconnect the mixed water solenoid valve connection tube (17).

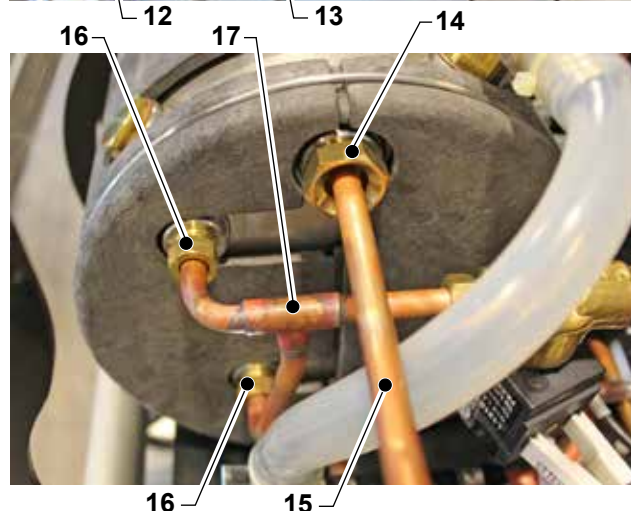

EN

- Unscrew the nut (18) of the boiler drain tube.



- Cut the strap (19) and remove the safety valve drain tube (20).
- Pull out the boiler upwards.



7.26 Replacing the steam tap

- Remove the cup heating plate as described in the relevant paragraph.
- Close the tap (1) pertaining to the steam tap to be replaced.

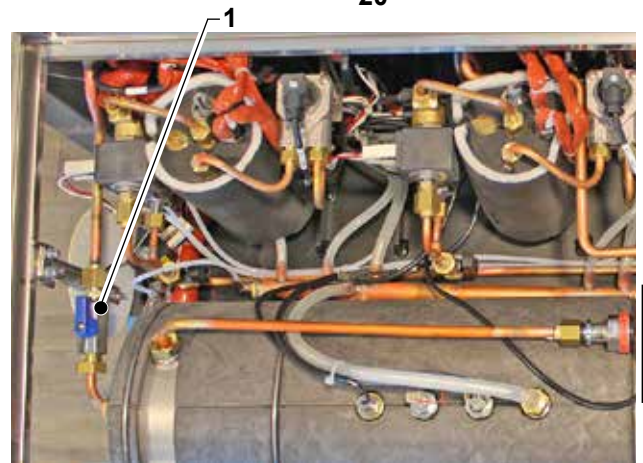

- Unscrew the nut (2) and disconnect the tube (3).
- Unscrew the nut (4) fastening the tap to the machine body.

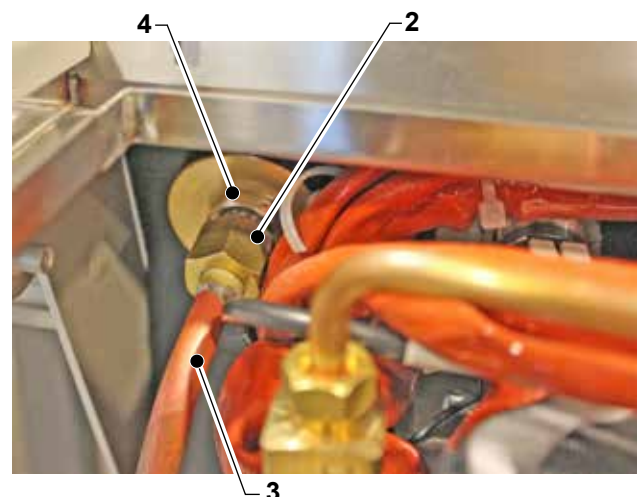

EN

- Remove the tap (5) from the front.

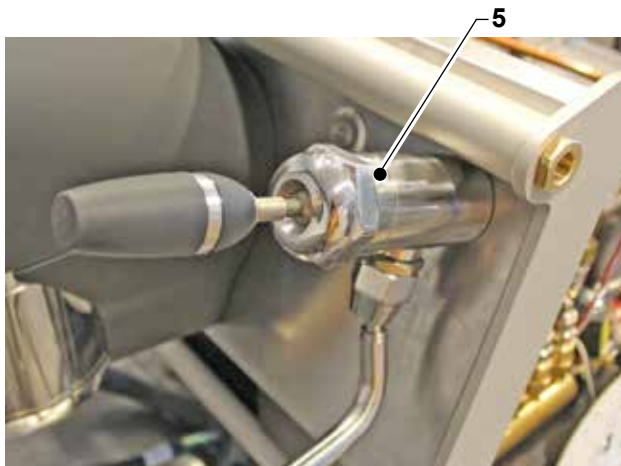

7.27 Replacing the safety thermostat.

- Remove the RH side panel as described in the relative paragraph.
- Unscrew the two screws (1), disconnect the thermostat (2) from the support square and disconnect the Faston connectors.

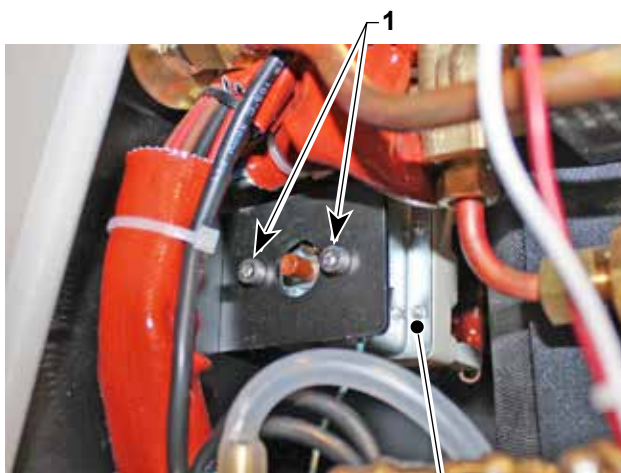

- Cut the strap (3) and (4) and pull out the bulb (5).
- When reassembling, pay attention to properly connect the Faston connectors and properly position the straps.



EN

7.28 Replacing the water dispensing tap button

- Undo the two screws (1) and remove the ring nut (2).

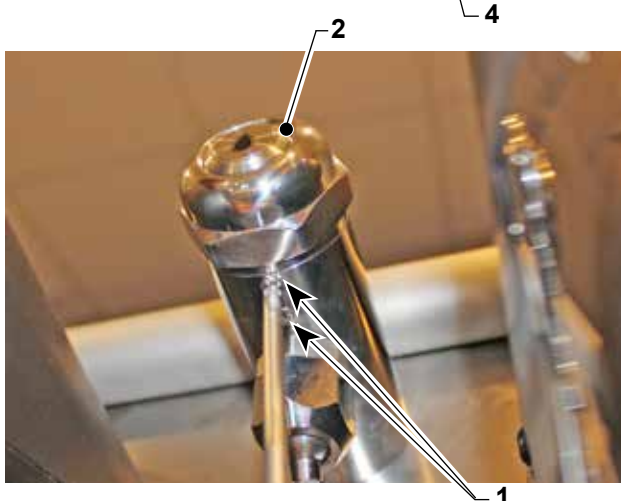

- Loosen the screws (3) and disconnect the wires (4).
- When reassembling, properly reconnect the wires (4).

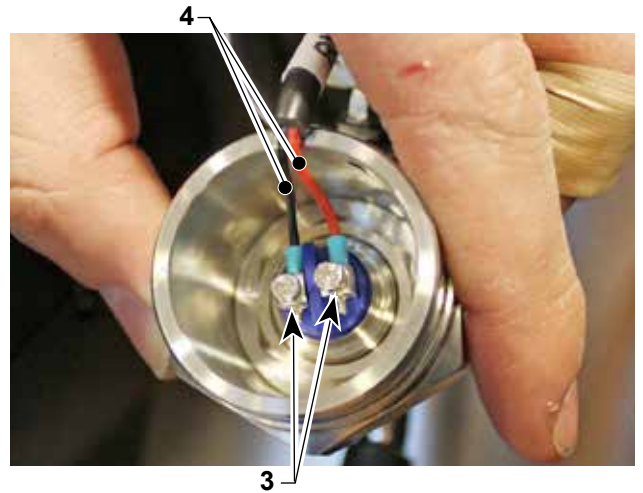

7.29 Replacing the LED bar

- Remove the left panel with shoulder and the lower front panel as described in the relevant paragraphs.
- Unscrew the three screws (1).

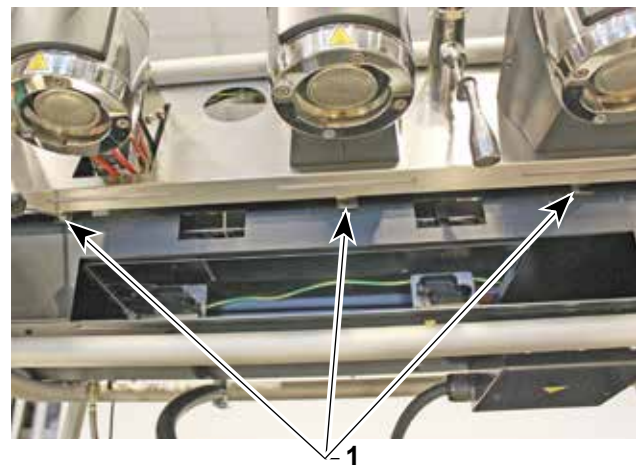

- Disconnect the connector (2).

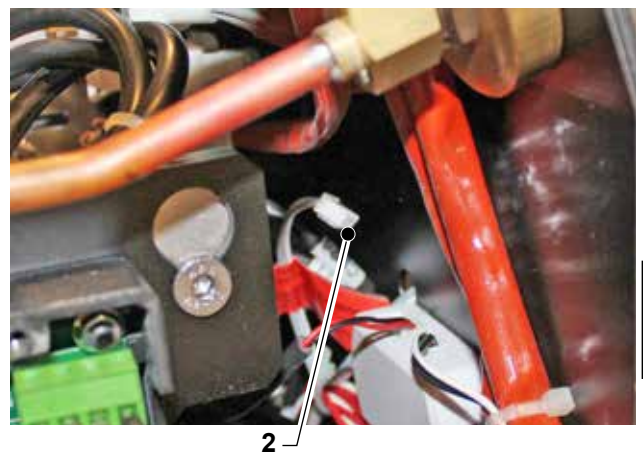

- Pull out the LED bar (3) from the side.

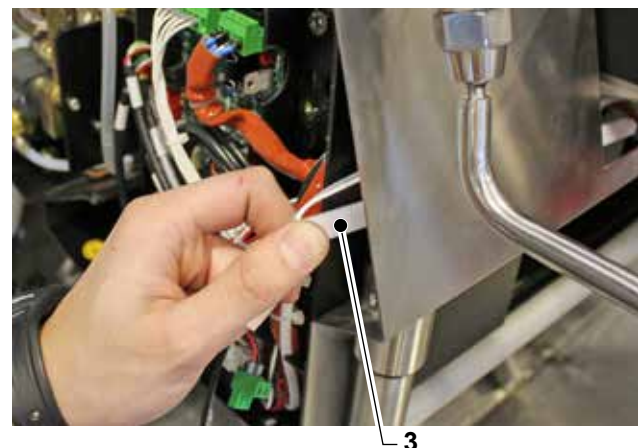

EN

7.30 Replacing the main switch.



Make sure that the main switch upstream of the machine is in OFF position, then post a sign on the main switch saying "Maintenance in progress" so that no one turns on the power during this operation.

- Remove the cup heating plate as described in the relevant paragraph.
- Cut the strap (1)
- Disconnect all the connectors (2).
- Unscrew the ring nut (3).

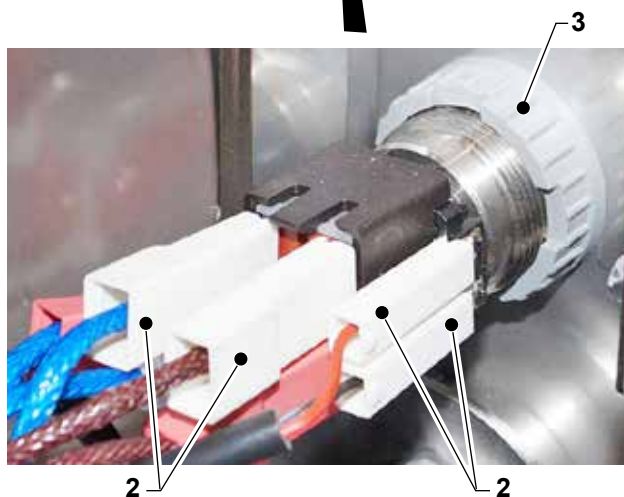
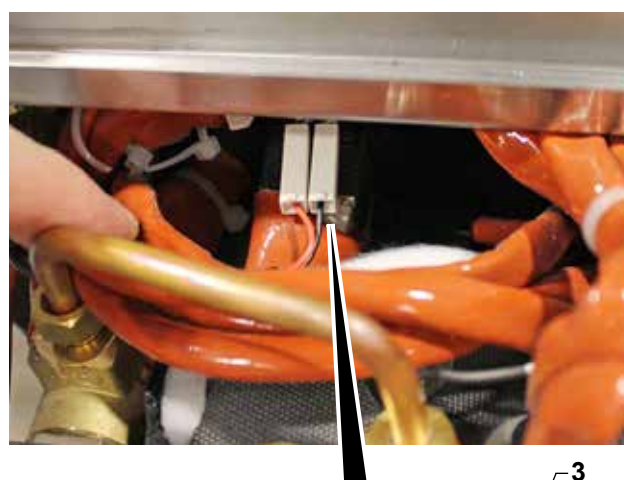
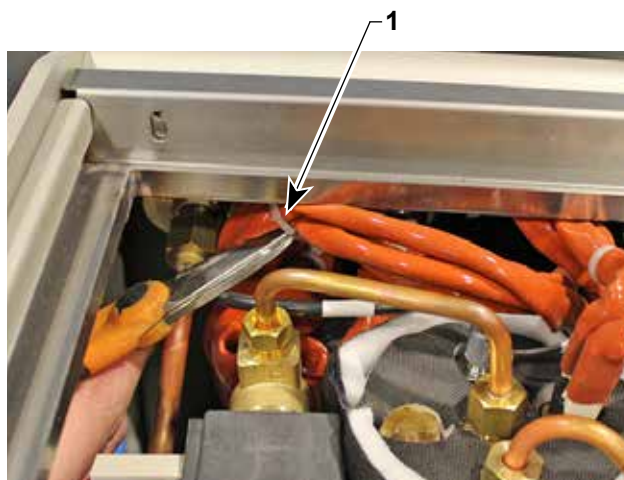

- Remove the switch (4).
- Reassemble everything in reverse order, referring to the attached wiring diagram for electrical connections.



EN

7.31 Removing the head and gaskets

- Leverage with a screwdriver to remove the head (1) and relevant gasket (2).



- Insert the new gasket (2) on the head (1).
- The bevel corners "A" of the gasket must be facing upward.



- Remove the filter from the filter holder (3) and assemble the head with gasket on the filter holder (3).



- Wet the head with water and assemble the filter holder (3) on the machine pressing thoroughly.
- Lock the filter holder (3).



EN

8. PROGRAMMING BY THE TECHNICIAN

- To access the programming mode, bring the machine to the electronic OFF and keep the central button (1) pressed, then press button (2), the display shows "oFF" and button (2) flashes.



- Press and keep pressed button (1) until "PASS-WORD" appears on the display (3); press button (1) five times to enter the programming mode; the default password is "11111".

Programming by the technician follows drill-down screens with the various programming sequences, therefore scroll through the sequences and confirm the set data until reaching the desired sequence to be modified.

The programming sequences are:

- Language
- Name
- Service tel.
- Number of units
- Chrono function
- Intake + coffee
- Watt
- Steam pressure transducer
- Pump pressure offset
- Programming doses
- Four doses
- Displacement counter offset 1
- Displacement counter offset 2
- Displacement counter offset 3
- Sensitivity
- Maintenance cycles
- Temperature
- Boiler temperature
- Unit 1 temperature offset
- Unit 2 temperature offset
- Unit 3 temperature offset
- Inactivity time
- Rest temperature offset
- Filling timeout
- Water filter
- Number of credits
- Cooling cycle
- Password change



8.1 Language

In this section, you can set the language for the messages shown on the display.

- press the button “☺” or “☹” to change language; press button “☺” to confirm and move to the next section.

The available languages are:

Italian, English, French, German, Spanish.



8.2 Name

The machine name is shown in this section

- Press the button “☺” to go to the next section.



8.3 Service tel.

In this section, you can set the phone number of the service centre (the modifiable number blinks).

- to set the number, press button “☺” to confirm the number and move to the next number by pressing button “☹”;
- Press the button “☺” to confirm the phone number set and go to the next section.



8.4 Number of units

This section is used to set the number of units, which must always be "3".

- Press the button “☺” to confirm the selection and go to the next section.



8.5 Chrono function

The Chrono function allows displaying the number of seconds the coffee is dispensed for on the unit display.

- Press button “☕” to enable or disable the function.
- Press the button “☕” to confirm the selection and go to the next section.



8.6 Intake + coffee

In this section, you can enable or disable loading water while coffee is being dispensed;

- to keep the pressure constant, set this to “DISABLED” otherwise set it to “ENABLED”;
- Press button “☕” to enable or disable the function.
- Press the button “☕” to confirm the selection and go to the next section.



8.7 Watt

This function is used to set the machine power between a minimum of 3500 watt and a “Full” maximum of 8750 watt; the default setting is 6500 watt.

- Press button “☕” or “☕” to change watt.
- Press the button “☕” to confirm the selection and go to the next section.



EN

8.8 Steam pressure transducer

This function is used to enable or disable the pressure transducer positioned above the service boiler.

- In this case the pressure transducer must be ENABLED.
- Press the button “☕” to go to the next section.



8.9 Pump pressure offset

This function displays the difference between the set pressure and the actual pump pressure.

This is set to "0.8" and must not be changed.

- Press the button "☕" to go to the next section.



8.10 Program doses

With this function, you can enable or disable programming doses by means of the buttons.

Leave it ENABLED in this case.

- Press the button "☕" to go to the next section.



8.11 Four doses

This functions is used to enable the button multifunction; leave it selected to "YES".

- Press button "☕" once to dispense a short coffee.
- Press button "☕" twice to dispense two short coffees.
- Press button "☕" once to dispense a long coffee.
- Press button "☕" twice to dispense two long coffees.
- Press the button "☕" to go to the next section.



8.12 Displacement counter offset 1-2-3

- If there are discrepancies between the set ml and the dispensed ml, the setting can be adjusted by pressing the button "☕" or button "☕"
- Press the button "☕" to confirm the selection and go to the next section.



EN

8.13 Sensitivity

This section is used to select the type of sensitivity of the boiler water level probe:

- Use button “☺” or button “☹” to set the sensitivity to “Low” - “Average” - “High” according to the water acidity; with high water acidity, a low sensitivity must be set for the probe, while a high sensitivity must be set with low water acidity.
- Typically, the “MEDIUM” sensitivity covers 90% of cases.
- Press the button “☺” to confirm the selection and go to the next section.



8.14 Maintenance cycles

In this section, you can set after how many dispensing cycles the machine requires maintenance.

- Press the button “☺” or “☹” to set the cycles.
- When the set number of cycles has been reached, the service phone number appears on the display.
- Press the button “☺” to confirm the selection and go to the next section.



8.15 Temperature

Check that "ENABLED" is set in this section.

- Press the button “☺” to go to the next section.



8.16 Temperature (C° / F°)

In this section, you can set the temperature scale to °C or °F:

- Press the button “☺” or “☹” to set the scale.
- Press the button “☺” to confirm the selection and go to the next section.



8.17 Boiler temperature

Check that the service boiler temperature is set to 124°C / 255°F in this section.

- Press the button “☺” to go to the next section.



8.18 Unit 1-2-3 temperature offset

If there are discrepancies between the set temperature and the actual temperature, they can be corrected by increasing or decreasing the temperature of the unit.

- Press the button “☺” or “☹” to set the value.
- Press the button “☺” to go to the next section.



8.19 Inactivity time

If the machine is installed in an outdoor kiosk, the temperature is low and the machine is inactive for a few minutes, the unit temperature may drop 0.5 °C or 1°C.

- You can set an inactivity time beyond which the machine automatically increases the unit temperature to a value set in the next screen "REST TEMP. OFS".
- Press the button “☺” or “☹” to set the values.
- Press the button “☺” to go to the next section.



In this section, you can set the degrees of unit temperature increase in order to compensate for inactivity or a cold climate.

- Normally this function is not used, so set the value to "0" in both screens to disable the function.
- Press the button “☺” to go to the next section.



EN

8.20 Filling timeout

The water filling solenoid valve opening time can be set in this section; when this time has elapsed the machine stops if filling has not yet occurred.

- Press the button “☺” or “☹” to set the value (normally 120 seconds is set).
- Press the button “☺” to confirm the selection and go to the next section.



8.21 Water filter

In this section, you can set after how many litres of water used to dispense coffee, the water filter needs to be replaced.

- Press the button “☺” or “☹” to set the litres.
- Press the button “☺” to confirm the value and go to the next section.



8.22 Number of credits

This section can be used to set after how many coffees the machine stops; this function can be enabled or disabled;

- Press the button “☺” or “☹” to enable or disable this functions or set the max. no. of coffees to be dispensed;
 - when “DISABLED” is selected, press button “☺” to go to the next section;
 - if the quantity of coffees after which the machine is stopped is set, the value is set with button “☺” or “☹”.
- Press the button “☺” to confirm the value and go to the next section.



8.23 Cooling cycle

The function allowing to empty the service boiler to regenerate the water within can be enabled in this section.

- Press the button “☺” or “☹” to select "YES" or "NO".
- When “YES” is selected, the emptying cycle starts automatically by disabling the heating elements, then the machine automatically quits the technical menu at the end of the cycle.
- This operation can be stopped by pressing any buttons on the first pushbutton panel on the left.
- Select “NO” and press button “☺” to go to the next section.



8.24 Password

In this section, you can change the password to access the technician section.

- Use the button “☕” to set “NO” to leave the current password or “YES” to change it:
- If you have selected “NO”, press the button “☕” to exit the technician menu;
- If you have selected “YES”, press the button “☕” to confirm the selection and go to the next section where the blinking number is the modifiable one.



- Use the buttons of the first two units on the left to set the password.
 - Button (A) to enter number “1”
 - Button (B) to enter number “2”
 - Button (C) to enter number “3”
 - Button (D) to enter number “4”
 - Button (E) to enter number “5”
 - Button (F) to enter number “6”
- Once the new password is set, the machine automatically quits the technical menu.

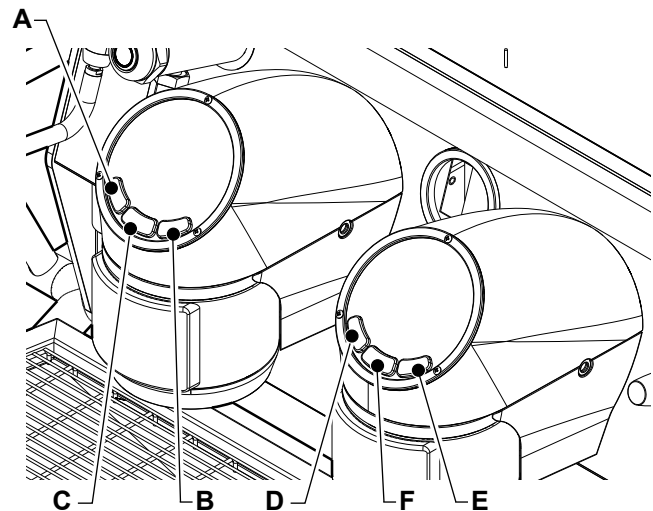

EN

8.25 Cash register function and cleaning

From Firmware revision 1.38 it is possible to connect the cash counter to the espresso machine.

Connect the cash register to the control unit CN41 connector (1) and fix the body to the sheet metal on the left (2)

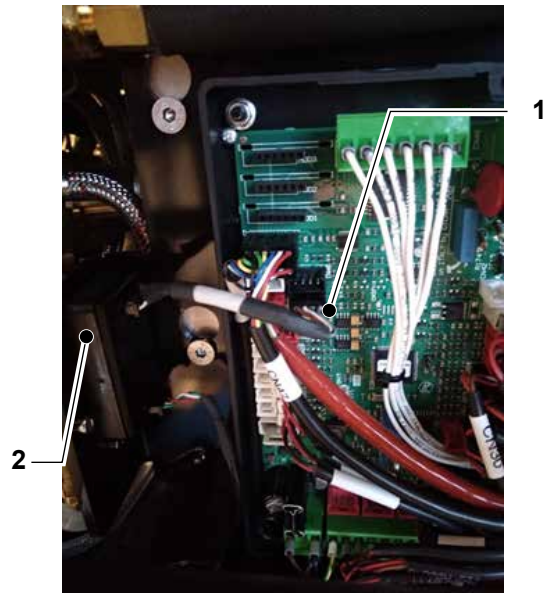

-Switch the machine to electronic OFF: press button (C), then press button (B) always keeping button (C) pressed. On the display appear "oFF" , button (B) blinks.



EN

-Press and keeping pressed button (C) until it appears on the display the message "PASSWORD"; press button (C) five times to enter in the technical programming;



-Switch the machine to electronic OFF (F-E) using the group n°2, the second group of the machine starting from left.

-Display'll show the message "CASH REGISTER", use button (A-B) of group n° 1 to able/disable cash register function, press button (C) to confirm. Default disable.





-After the cash register function you will find the automatic washing function, use button (A - B) to able/disable the command and press button (C) to confirm and return to the machine electronic OFF. Default enable.

In case of cash register enabled, cleaning menu (ENABLED as default) allows to disable (if in 'OFFF') the group heads cleaning cycle since it could be used to brew coffee.



EN

8.26 Alarms list

Below the list of alarms that appear on the machine group head display:

-AL1 group over-heating error, temperature probe in short-circuit or faulty;

-AL2 group minimum temperature error or temperature probe unplugged;

-AL5 pre-heating boiler over-heating error, temperature probe in short circuit or faulty;

-AL6 pre-heating boiler minimum temperature or temperature probe unplugged;

-ER1 group solenoid valve in short circuit;

-ER2 group solenoid valve disconnected or faulty;

-BLINKING flowmeter not working;
BUTTON

Below the list of alarms that appear on the machine display:

-AL1 steam boiler over-heating error, temperature probe in short-circuit or faulty;

-AL2 steam boiler minimum temperature, temperature probe unplugged;

-AL3 steam boiler over-pressure issue, faulty pressure transducer;

-AL4 steam boiler under-pressure issue, pressure transducer disconnected;

EN

-ER1 hot water solenoid valve in short-circuit;

-ER2 hot water solenoid valve disconnected;

-ER3 cold water solenoid valve in short-circuit;

-ER4 cold water solenoid valve disconnected;

-ER5 filling-up solenoid valve in short-circuit;

-ER6 filling-up solenoid valve disconnected;

9. HYDRAULIC DIAGRAM

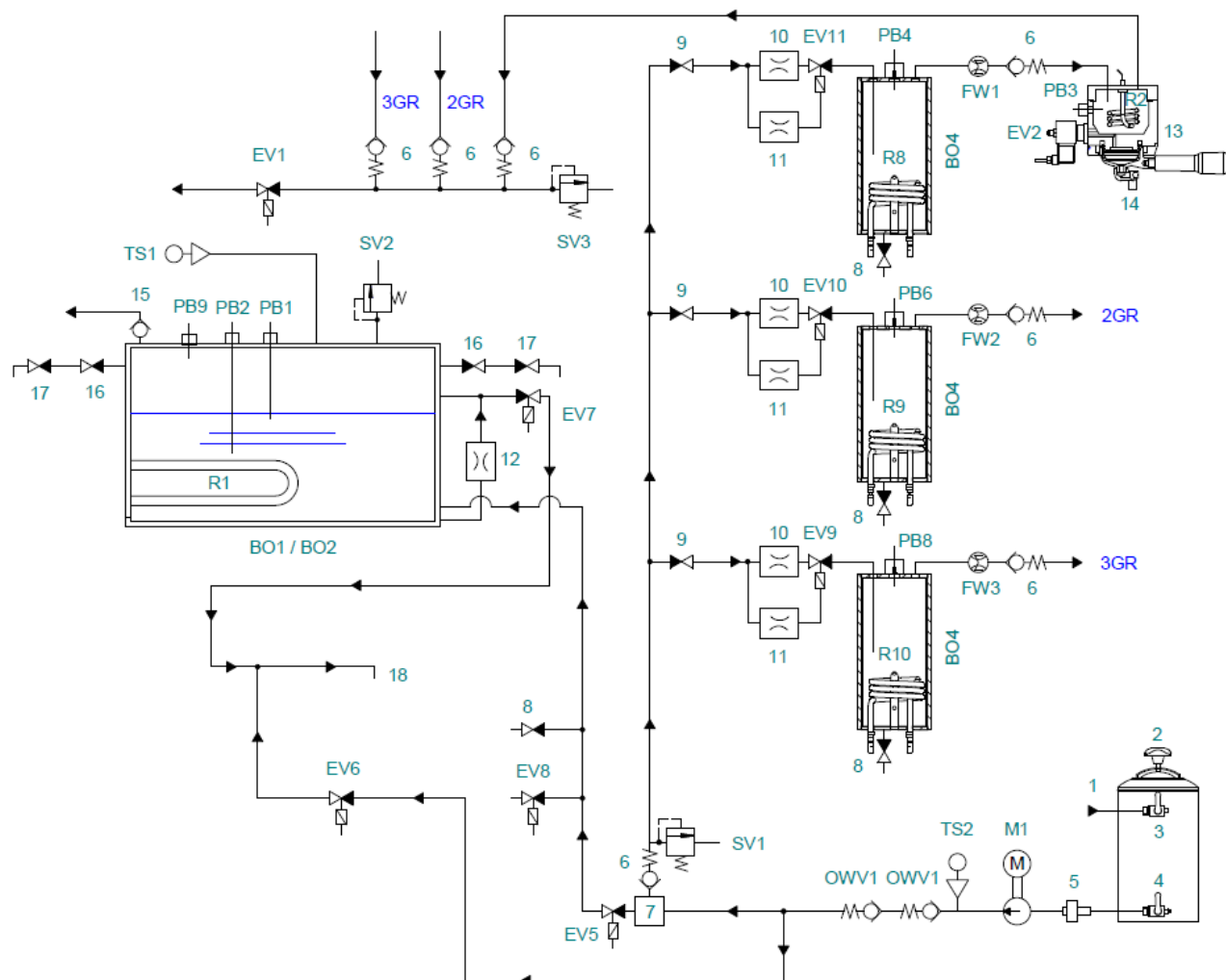

LEGEND

- 1) Water grid supply
- 2) Softener
- 3) Water inlet tap
- 4) Water outlet tap
- 5) Filter
- 6) Check valve
- 7) Loading flange with filter
- 8) Boiler drain tap
- 9) Coffee circuit tap
- 10) Gigueur 0.3mm
- 11) Gigueur 1mm
- 12) Gigueur 2mm
- 13) Dispensing unit
- 14) Filter holder
- 15) Antivacuum valve
- 16) Steam shut-off tap
- 17) Steam tap
- 18) Hot water outlet
- BO2) Steam boiler (2 units)
- BO1) Steam boiler (3 units)
- BO4) Coffee boiler

- EV1) Bleed solenoid valve
- EV2) Dispensing unit solenoid valve
- EV5) Solenoid valve for automatic filling
- EV6) Mixed cold water solenoid valve
- EV7) Steam intake solenoid valve
- EV8) Cooling cycle solenoid valve
- EV9-10-11) Pre-infusion solenoid valve
- FW1-2-3) Displacement counter
- M1) Motor with 300 litre pump
- OWV1) Loading flange check valve
- PB1) Max level probe
- PB2) Minimum level probe
- PB3) Coffee unit temperature probe
- PB4-6-8) Coffee boiler temperature probe
- PB9) Steam boiler temperature probe
- R1) Steam boiler heating element
- R2) Unit heating element
- R8-9-10) Coffee boiler heating element
- SV1) 12Bar expansion valve
- SV2) Safety valve
- SV3) 12Bar adjustable expansion valve
- TS1) Boiler pressure transducer
- TS2) Pump pressure transducer

EN

10. WIRING DIAGRAM

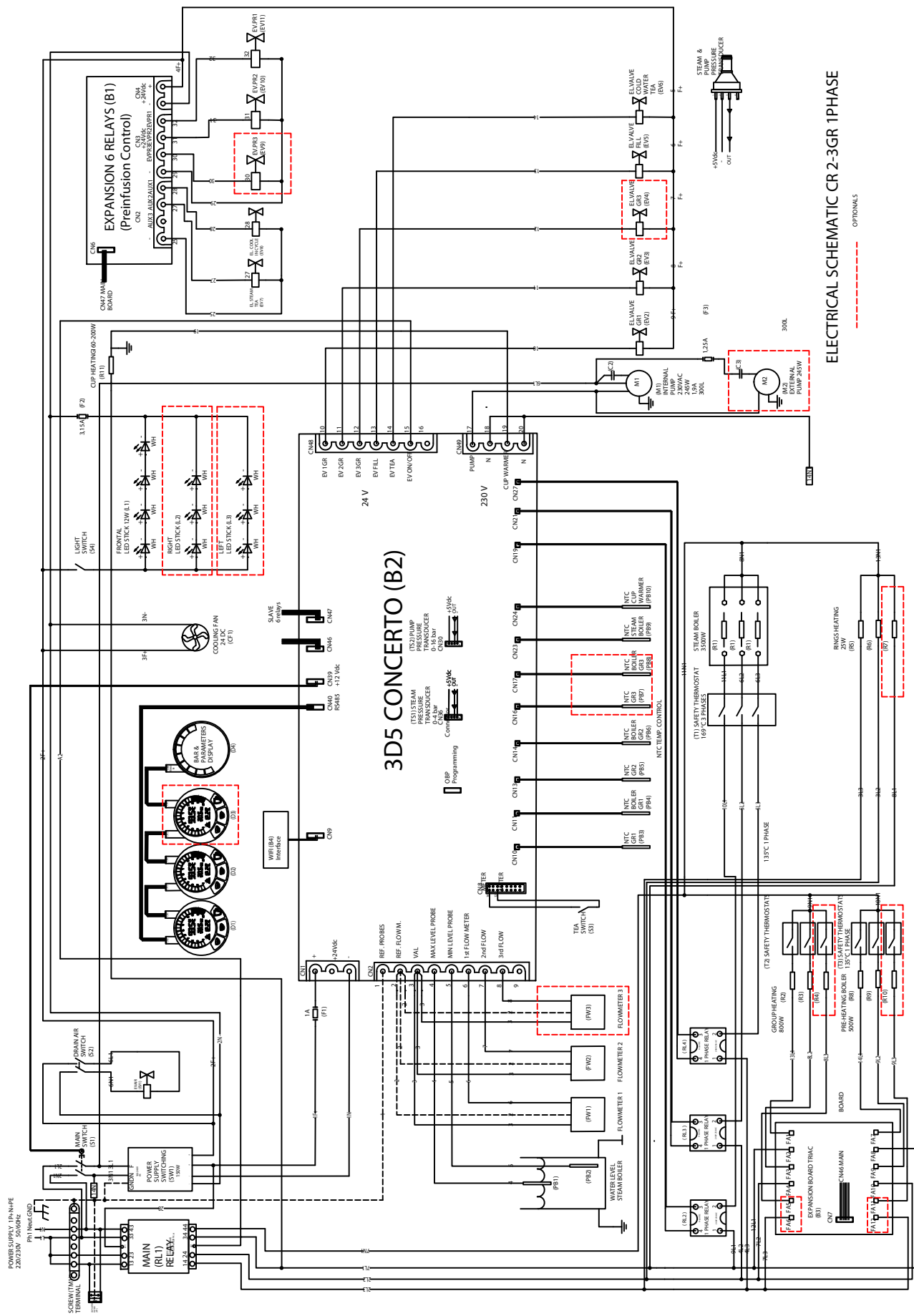

EN

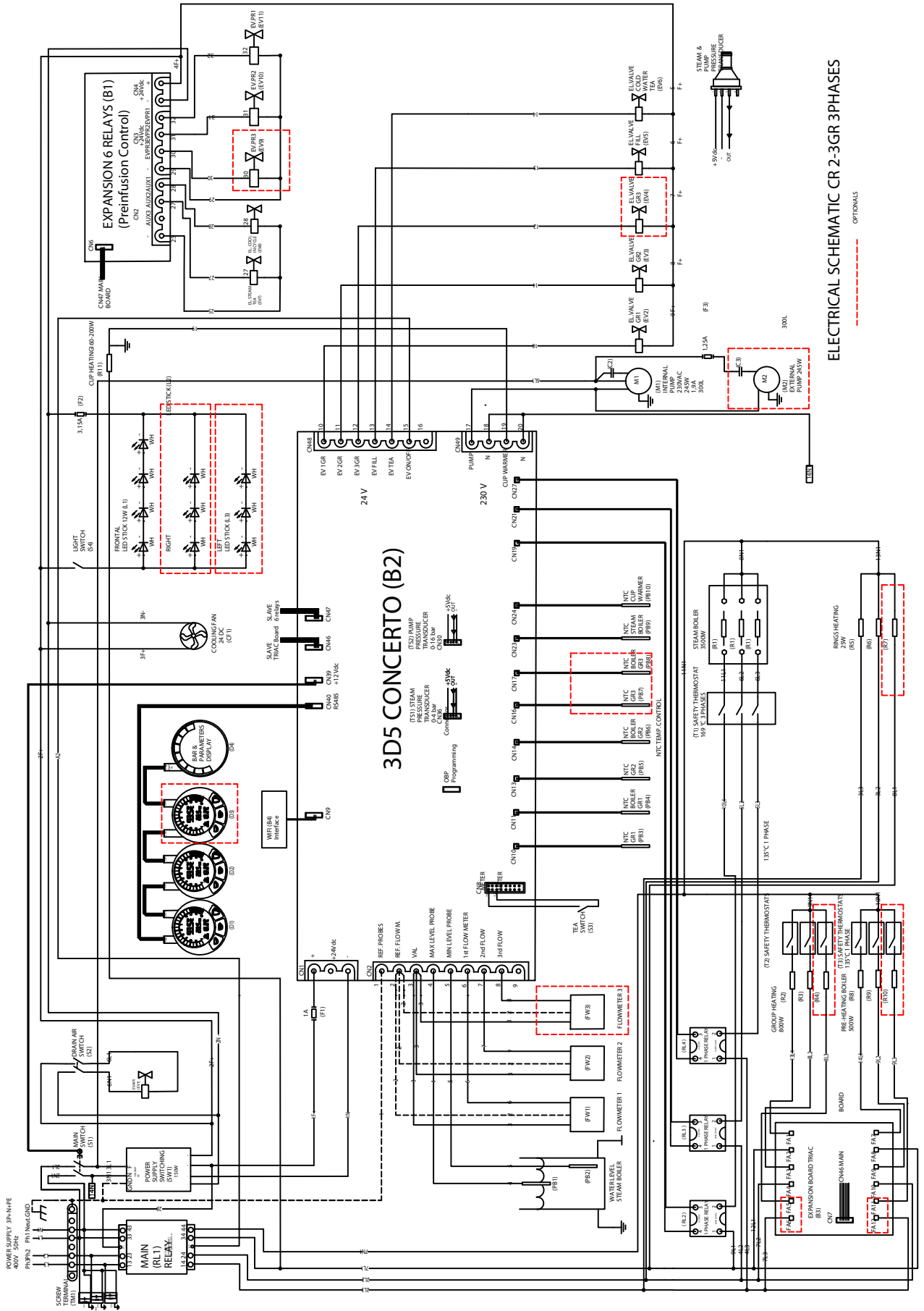

ELECTRICAL SCHEMATIC CR 2-3R 3PHASES

OPTIONALS



Think
about
it!

SANREMO s.r.l.
Via Bortolan, 52
31050 Vascon di Carbonera (TV)
ITALIA
tel. +39 0422 448900
fax +39 0422 448935
p.iva /c.f. 03239750262
www.sanremomachines.com
info@sanremomachines.com